

AIS Message Exchanges

The information in this document is provided as a guide only and is not professional advice, including legal advice. It should not be assumed that the guidance is comprehensive or that it provides a definitive answer in every case.

Version Control		
Version	Date	Change
0.1	04/10/2019	Initial document published
1.01	03/04/2020	<ul style="list-style-type: none"> Two instances of IM099 informational messages that are not sent to the traders (Payment deadline expired in chapters 5.3.8, 5.3.9) were removed. Deleted a redundant diagram in 'Standard Customs Declaration' chapter (Chapter 5.3). State transition diagrams have been added for all cases except one EIDR case. <p>The following messages was added and removed from the documentation:</p> <p>Added messages:</p> <p>IM862 – Declaration Amendment Request Cancellation IM864 – Declaration Invalidation Request Cancellation IM882 – Documents Upload Request Cancellation IM884 – Documents Presentation Request Cancellation TS333 – Presentation Notification Rejection TS351 – Temporary Storage Do Not Import</p> <p>Deleted messages:</p> <p>TS361 – Temporary Storage Declaration Entry Permitted</p> <p>Message Sequence Diagrams updated:</p> <p>6.2.2 – Placement - Standard Declaration 5.2.4 – Simplified Customs Declaration with Supplementary Waiver 5.2.3 – Simplified Customs Declaration 4.2.1.2 – Receipt of pre-lodged Temporary Storage Declaration (G4) 4.2.1.1 – Receipt of Temporary Storage Declaration and Presentation Notification, combined (G4+G3)</p> <p>State Transition Diagrams updated:</p> <p>4.2.1.2 –Receipt of pre-lodged Temporary Storage Declaration</p>
1.02	18/06/2020	Version 1.02 is aligned to AIS release A.11

		No changes since the previous version (1.01)
1.03	08/09/2020	Version 1.03 includes the specification of the release A.15 Updated use cases and sequence diagrams. Removed the flows for the D3 Amendment and invalidations
1.04	10/11/2020	Version 1.04 includes the specification of the release A.15.5.1 No changes since the previous version (1.03)
1.05	23/11/2020	Version 1.05 includes the specification of the release A.17.1 No changes since the previous version (1.04)
1.06	19/01/2021	Version 1.06 includes the specification of the release A.18 No changes since the previous version (1.05)
1.07	24/03/2021	Version 1.07 includes the new messages for the H7 declarations The new H7 declarations comply with the EUCDM 6.0 r1. This has a completely different structure than the H1, ..., H6 and I1 declarations that comply with the EUCDM 5.1.
1.08	17/06/2021	Version 1.08 includes the specification of the release A.20 No changes since the previous version (1.07)
1.09	20/09/2021	Version 1.09 includes the specification of the release A.20.2 No changes since the previous version (1.08)
1.10	07/10/2021	Version 1.10 includes the specification of the release A.20.3 No changes since the previous version (1.09)
1.11	23/11/2021	Version 1.11 includes the specification of the release A.20.4 No changes since the previous version (1.10)
1.12	14/02/2022	Version 1.12 includes the specification of the release A.20.5 No changes since the previous version (1.11)
1.13	27/04/2022	Version 1.13 includes the specification of the release A.20.6 Changes: Section 5.2.2.1 Pre-lodged Standard Customs Declaration (H1, H6, I1) >>> Added Alt 14 – Tariff validation or calculation error after arrival and presentation Section 5.2.2.2 Pre-lodged Standard Customs Declaration (H7) >>> Alt 13 – Tariff validation or calculation error after arrival and presentation
1.14	14/06/2022	Version 1.14 includes the specification of the release A.20.7 No changes since the previous version (1.13)

1.15	18/11/2022	Version 1.15 includes the specification of the release A.20.8 No changes since the previous version (1.14)
1.16	08/05/2023	Version 1.16 includes the specification of the release A.23.1 No changes since the previous version (1.15)
1.17	17/07/2023	Version 1.16 includes the specification of the release A.23.2 No changes since the previous version (1.16)

Table of Contents

1	INTRODUCTION	7	
1.1	Purpose.....	7	
1.2	Related documents	7	
2	DATASETS	8	
3	ENTRY OF GOODS.....	13	
3.1	Messages.....	13	
3.2	Use Cases.....	13	
3.2.1	D3 Electronic Transport Document	13	
4	TEMPORARY STORAGE	15	
4.1	Messages.....	15	
4.2	Use Cases.....	16	
4.2.1	Placement under Temporary Storage and Monitoring	16	
4.2.2	End of Temporary Storage (Reserved for future use)	21	
4.2.3	Temporary Storage Declaration Amendment	22	
4.2.4	Temporary Storage Declaration Invalidation	24	
5	IMPORT - RELEASE FOR FREE CIRCULATION.....	26	
5.1	Messages.....	26	
5.2	Use Cases.....	26	
5.2.1	Standard Customs Declarations	26	
5.2.2	Pre-lodged Standard Customs Declarations	33	
5.2.3	Simplified Customs Declaration	43	
5.2.4	Simplified Customs Declaration with Supplementary Waiver	46	
5.2.5	Pre-Lodged Simplified Customs Declaration	49	
5.2.6	Pre-Lodged Simplified Customs Declaration with supplementary waiver	53	
5.2.7	Supplementary Declaration	57	
5.2.8	EIDR with Presentation Notification and Supplementary Declaration (Type Z)	60	
5.2.9	EIDR with Presentation notification waiver and Supplementary Declaration (Type Z)	63	
5.2.10	Amendment of the Customs Declaration	64	
5.2.11	Invalidation of the Customs Declaration	75	
6	IMPORT - SPECIAL PROCEDURES	81	
6.1	Messages.....	81	
6.2	Use Cases.....	81	
6.2.1	Prior Import for Outward Processing	81	
6.2.2	Placement - Standard Declaration for Special Procedure (H1, H2, H3, H4, I1)	86	
6.2.3	Simplified and Supplementary Customs Declaration for a Special Procedure	89	
6.2.4	EIDR with Presentation Notification and Supplementary Declaration (Type Z)	95	
6.2.5	EIDR with Presentation notification waiver and Supplementary Declaration (Type Z)	98	

7	IMPORT - CONTROLS	100
7.1	Messages	100
7.2	Use Cases.....	101
7.2.1	Declaration Amendment Request	101
7.2.2	Declaration Invalidation Request	103
7.2.3	Request Document Presentation	104
7.2.4	Request Document Upload	104
8	IMPORT - REFUNDS	106
8.1	Messages	106
8.2	Use Cases.....	107
8.2.1	Refund Application	107
8.2.2	Deposit Refund Application	108
9	QUOTA ALLOCATION	110
9.1	Messages	110
9.2.1	Amendment notification for partial or deferred quota allocation	110

1 Introduction

1.1 Purpose

The purpose of this document is to describe the information (messages) Traders will be exchanging with the Revenue Commissioners.

This document is divided into the following functional areas:

- Entry of Goods
- Temporary Storage
- Import – Release for free circulation
- Import – Special Procedures
- Import – Controls
- Import – Refunds

For each functional area, the document contains:

- A Sequence Diagram describing the messages exchanged between Traders and the Revenue Commissioners at a logical level, this excludes technical details
- Declaration state transition diagrams. Where possible, state transition diagrams have been included that show all possible states that a declaration can acquire during processing and the action/messages that cause the transition.
- Summary Use Cases that describe the possible flows.

1.2 Related documents

This document should be read in conjunction with the following documents:

Document name	Description
AIS Message Structures	Contains the logical structure of all messages exchanged between traders and the Revenue Commissioners for AIS
AIS Codelists	Contains all codelists referred to within the message-structures document.
AIS Business Rules and Conditions	Contains all business rules and conditions referred to within the message-structures document and applied during message validation
AIS XSDs	Contains all message XSDs describing the business message content in XML.
AIS Trader Guide	Contains a 'box by box' guide for AIS import declarations.
AIS Message Structure and Schema Change Log	Contains the change log for the AIS Message Structures document and AIS XSD files.

2 Datasets

The following table contains a list of all the messages exchanged between Traders and the Revenue Commissioners for AIS e.g. entry, temporary storage, special procedures, release for free circulation etc.

Message	Name	Source	Description
Import			
ETD15	D3 - Electronic Transport Document	Trade	Trader submission of a D3 - Electronic Transport Document
ETD16	D3 Rejection message	Revenue	Informs Trade of a submitted D3 Rejection (Validation failed)
ETD28	D3 Acceptance	Revenue	Informs Trade of D3 Acceptance
IM099	General Notification and Request Information	Revenue	Generic (multi-purpose) informational message
IM404	Amendment Request Registration	Revenue	Informs Trade of Amendment Request Acceptance
IM405	Amendment Request Rejection	Revenue	Informs Trade of Amendment Request Rejection
IM409	Invalidation Request Decision	Revenue	Informs Trade of Invalidation Request Decision
IM413	Customs Declaration Amendment Request	Trade	Trader submission of a Customs Declaration Amendment Request
IM414	Invalidation Request	Trade	Trader submission of a Customs Declaration Invalidation Request
IM415	Customs Declaration	Trade	Trader submission of an Import Customs Declaration
IM415V	Customs Declaration Acknowledgment	Revenue	Informs Trade of Pre-lodged Customs Declaration Registration
IM416	Customs Declaration Rejection	Revenue	Informs Trade of Customs Declaration Rejection (Validation Failed)

Message	Name	Source	Description
IM428	Customs Declaration Acceptance or Goods Deemed to be Placed under Customs Warehousing Procedure	Revenue	Informs Trade of Customs Declaration Acceptance
IM429	Release Notification	Revenue	Informs Trade that goods can be Released
IM432	Presentation Notification	Trade	Trader submission of a Presentation Notification
IM433	Presentation Notification Rejection	Revenue	Informs Trade of Presentation Notification Rejection
IM451	Release Rejection	Revenue	Informs Trade of Release of goods Rejection
IM460	Control Notice	Revenue	Informs Trade of intended controls
IM462	Request Declaration Amendment	Revenue	Informs Trade that a Declaration Amendment is required by Customs
IM464	Request Declaration Invalidation	Revenue	Informs Trade that a Declaration Invalidation is required by Customs
IM482	Documents Request	Revenue	Informs Trade that additional Documents are required by Customs
IM483	Documents Received	Trade	Trader submission of Customs requested additional documents
IM484	Request Document Presentation	Revenue	Informs Trade that specific Documents must be presented to Customs in paper (originals) form.
IM493	Amendment notification for partial or deferred quota allocation	Revenue	Informs Trade of a Declaration Amendment effected by the system due to a Quota allocation response.

Message	Name	Source	Description
IM862	Declaration Amendment Request Cancellation	Revenue	Informs Trade that a previously issued Declaration Amendment Request by Revenue has been retracted.
IM864	Declaration Invalidation Request Cancellation	Revenue	Informs Trade that a previously issued Declaration Invalidation Request by Revenue has been retracted.
IM882	Documents Upload Request Cancellation	Revenue	Informs Trade that a previously issued Documents Upload Request by Revenue has been retracted.
IM884	Documents Presentation Request Cancellation	Revenue	Informs Trade that a previously issued Documents Presentation Request by Revenue has been retracted.
IM917	Syntax Error notification message	Revenue	Informs Trade of submitted message Syntax (Structural) Error(s)
Refunds			
RD409	Application for Deposit Refund Decision	Revenue	Informs Trade of Customs decision on an application for Deposit Refund
RD415	Application for remission of Customs debt	Trade	Trader submission of a Deposit Refund Application
RD416	Application for remission of Customs debt rejection	Revenue	Informs Trade of rejection of an application for Deposit Refund (Validation Failed)
RF409	Decision on Refund application	Revenue	Informs Trade of Customs decision on an application for Refund.
RF415	Application for remission of Customs debt	Trade	Trader submission of an Application for Refund

Message	Name	Source	Description
RF416	Application for remission of Customs debt rejection	Revenue	Informs Trade of rejection of an application for Refund (Validation Failed)
Temporary storage			
TS304	Temporary Storage Declaration Amendment Request Registration	Revenue	Informs Trade of Temporary Storage Declaration Amendment request acceptance
TS305	Temporary Storage Declaration Amendment Request Rejection	Revenue	Informs Trade of Temporary Storage Declaration Amendment request rejection
TS309	Temporary Storage Declaration Invalidation Decision	Revenue	Informs Trade of Temporary Storage Declaration Invalidation request decision
TS313	Temporary Storage Declaration Amendment Request	Trade	Trader submission of a Temporary Storage Amendment request
TS314	Temporary Storage Declaration Invalidation Request	Trade	Trader submission of a Temporary Storage Invalidation request
TS315	Pre-lodged Temporary Storage Declaration (G4) TSD and Presentation Notification, combined (G4+G3)	Trade	Trader submission of a Pre-lodged Temporary Storage Declaration (G4) Temporary Storage Declaration and Presentation Notification, combined (G4+G3)
TS315V	Pre-lodged Temporary Storage Declaration Registration	Revenue	Informs Trade of a pre-lodged Temporary Storage Declaration Registration
TS316	Temporary Storage Declaration Rejection	Revenue	Informs Trade of Temporary Storage Declaration Registration rejection (Validation Failed)
TS328	Temporary Storage Declaration Acceptance	Revenue	Informs Trade of Temporary Storage Declaration Registration acceptance

Message	Name	Source	Description
TS332	Presentation Notification	Trade	Trader submission of a Presentation Notification
TS333	Presentation Notification Rejection	Revenue	Informs Trade of Presentation Notification rejection (Validation Failed)
TS351	Temporary Storage Do Not Import	Revenue	Informs Trade of Temporary Storage Declaration rejection (Post Validation)

The required data elements for each dataset, the structure of the data elements within each dataset, as well as the business rules that apply on them can be found in the “AIS-Message-Structures” document.

3 Entry of goods

3.1 Messages

List of messages code and description that may be exchanged in the Entry of Goods stage.

ID	Description	Sent by
IM917	Syntax Error notification message	AIS
D3 – Electronic Transport Document		
ETD15	D3 - Electronic Transport Document	Trader
ETD16	ETD Rejection message	AIS
ETD28	ETD Acceptance	AIS

3.2 Use Cases

3.2.1 D3 Electronic Transport Document

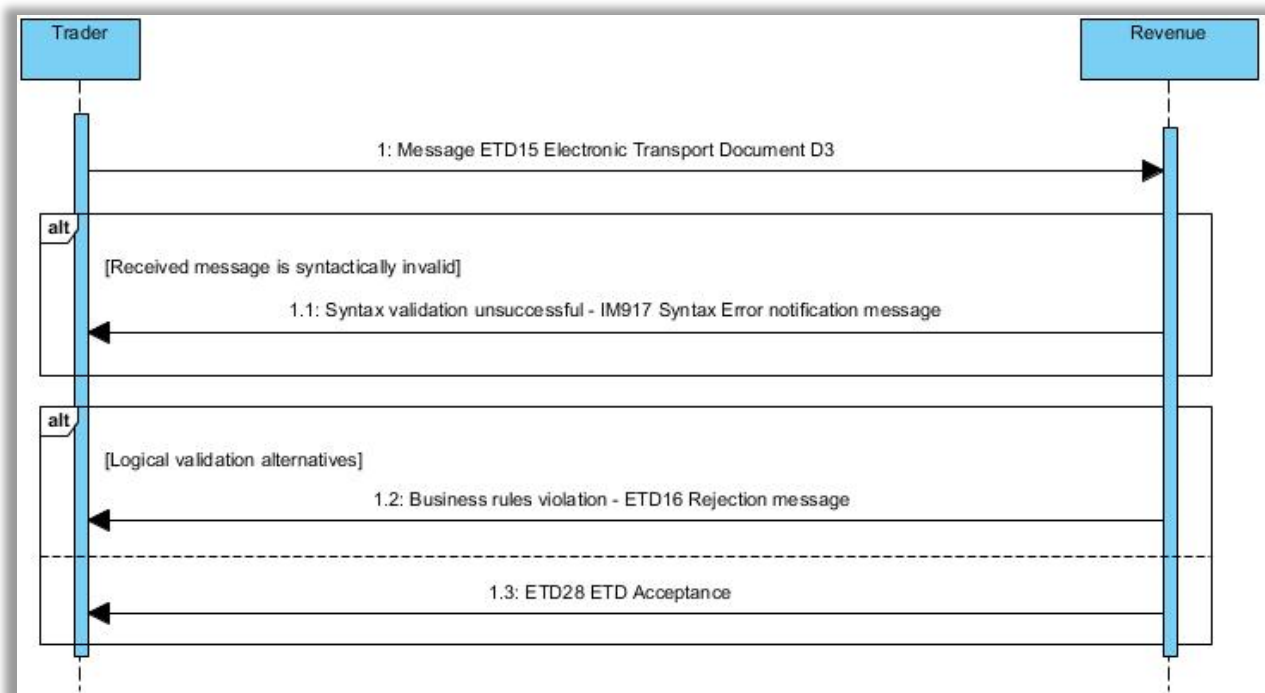

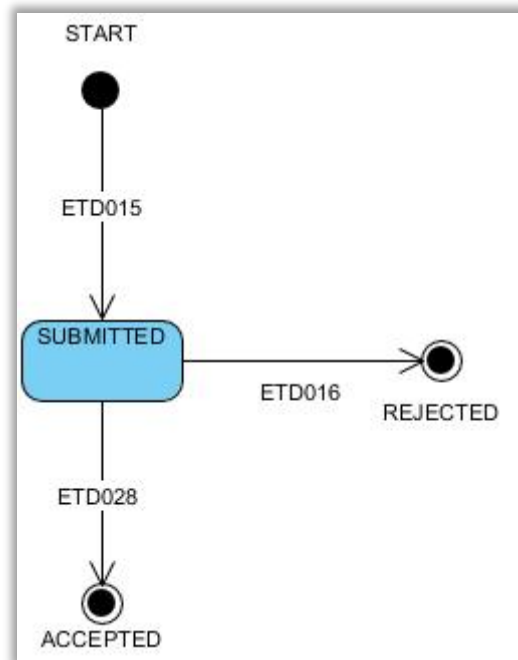

Core Flow (Happy Path) - D3 Electronic Transport Document

1. AIS receives an ETD15 message
2. The message is syntactically valid
3. The message is logically valid (No business rules violation)
4. AIS sends an ETD28 acceptance message to the Trader

Alt 1 - The declaration is syntactically invalid

1. The process follows the core flow up to step 1
2. The ETD15 message is syntactically invalid
3. AIS sends an IM917 Syntax Error message to the Trader

Alt 2 - The declaration is logically invalid

1. The process follows the core flow up to step 2
2. The ETD15 message is logically invalid (Business rules violation)
3. AIS sends an ETD06 rejection message to the Trader

4 Temporary storage

4.1 Messages

List of messages code and description that may be exchanged for Temporary Storage declaration processing:

ID	Description	Sent by
IM099	General Notification and Request Information message	AIS
IM917	Syntax Error notification message	AIS
Temporary Storage / Presentation Notification		
TS304	Temporary Storage Declaration Amendment Request Registration	AIS
TS305	Temporary Storage Declaration Amendment Request Rejection	AIS
TS309	Temporary Storage Declaration Invalidation Decision	AIS
TS313	Temporary Storage Declaration Amendment Request	TRADER
TS314	Temporary Storage Declaration Invalidation Request	TRADER
TS315	Temporary Storage Declaration	TRADER
TS315V	Temporary Storage Declaration Registration acceptance	AIS
TS316	Temporary Storage Declaration Rejection	AIS
TS328	Temporary Storage Declaration Acceptance	AIS
TS332	Presentation Notification	TRADER
TS333	Presentation Notification Rejection	AIS
TS351	Temporary Storage Do Not Import	AIS

4.2 Use Cases

4.2.1 Placement under Temporary Storage and Monitoring

4.2.1.1 Receipt of Temporary Storage Declaration and Presentation Notification, combined (G4+G3)

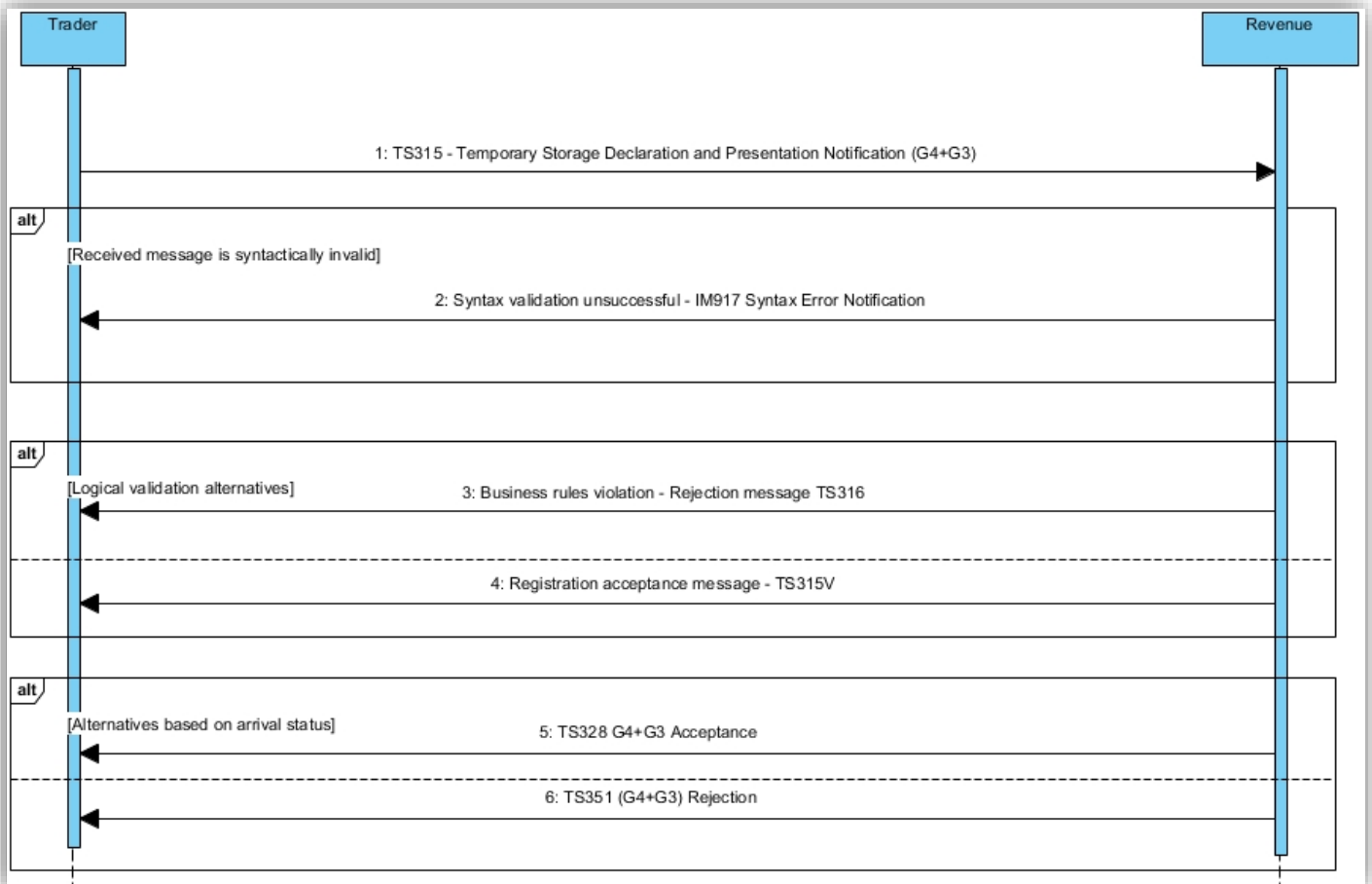

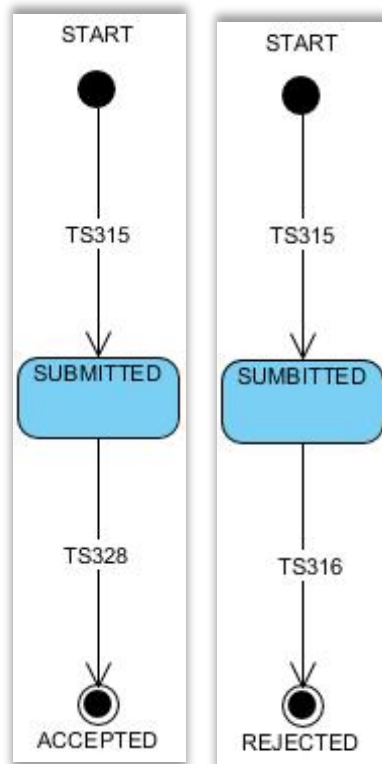

Core Flow (Happy Path) - Receipt of Temporary Storage Declaration and Presentation Notification, combined

1. AIS receives an TS315 (G4+G3) message
2. TS315 (G4+G3) is syntactically valid
3. TS315 (G4+G3) is logically valid (No business rules violation)
4. AIS sends TS315V (including the MRN)
5. The G4 + G3 declaration status is set to [REGISTERED]
6. AIS checks the arrival status of the declaration
7. The declaration is arrived
8. AIS forwards a TS328 registration message to the Trader
9. The G4 + G3 declaration status is set to [ACCEPTED]

Alt 1 - TS315 (G4+G3) is syntactically invalid

1. The process follows the core flow up to step 1
2. A TS315 message is syntactically invalid
3. AIS forwards an IM917 Syntax Error Notification message to the Trader

Alt 2 - TS315 (G4+G3) is logically invalid

1. The process follows the core flow up to step 2
2. A TS315 message is logically invalid (Business rules violation)
3. AIS forwards a TS316 rejection message to the Trader
4. The G4 + G3 declaration status is set to [REJECTED]

Alt 3 – Not arrived declaration

1. The process follows the core flow up to step 6
2. The declaration is not arrived
3. The G4 + G3 declaration status remains [REGISTERED]
4. Presentation timer expired and declaration not arrived
5. AIS sends message TS351 to the trader
6. The G4 + G3 declaration status is set to [NOT RELEASED]

4.2.1.2 Receipt of pre-lodged Temporary Storage Declaration (G4)

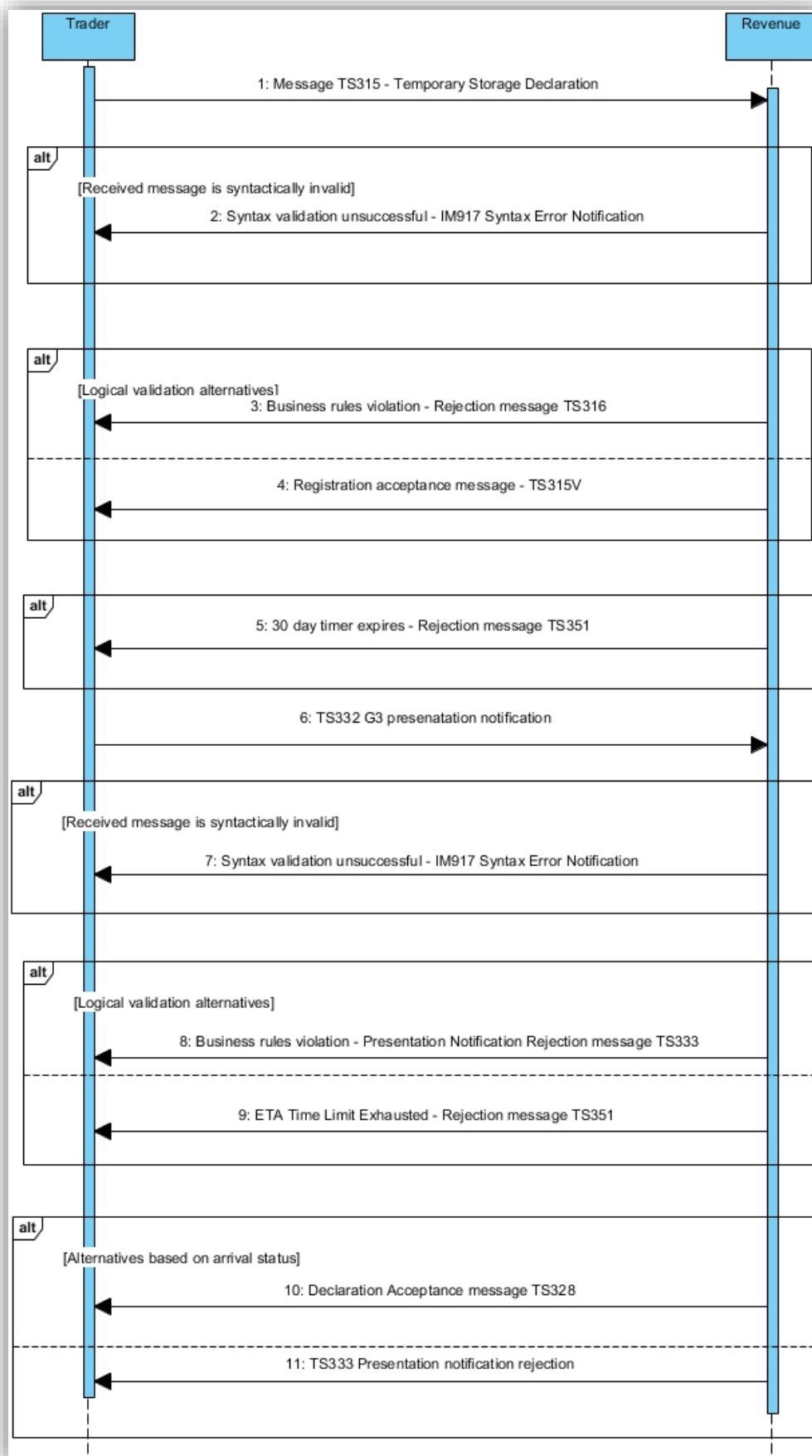

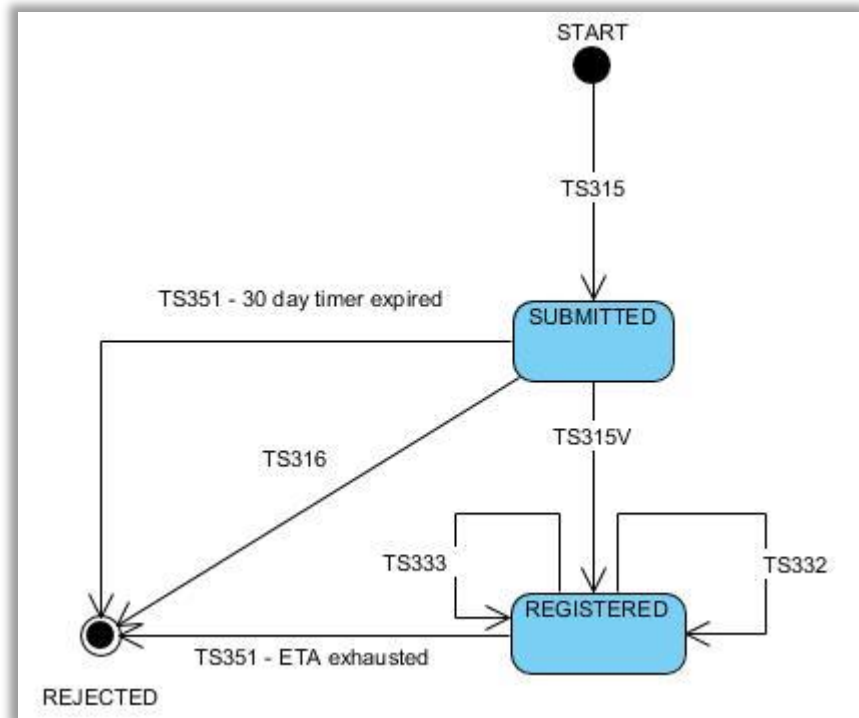
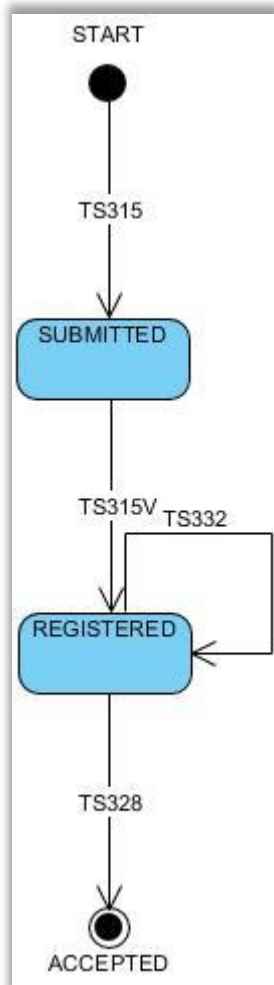

Core Flow (Happy Path) - Receipt of pre-logged TSD

1. AIS receives a TS315 message
2. TS315 is syntactically valid
3. TS315 is logically valid (No business rules violation)
4. The declaration is "pre-logged"
5. AIS sends TS315V
6. G4 declaration is set to status [REGISTERED]
7. AIS receives a TS332 Presentation Notification message
8. The message is syntactically valid
9. The message is logically valid (No business rules violation)
10. AIS checks the arrival status of the declaration
11. The declaration is arrived
12. AIS forwards a TS328 registration message to the Trader
13. G4 declaration is set to next status in the processing (arrived and presented)

Alt 1 - Pre-logged TSD is syntactically invalid

1. The process follows the core flow up to step 1
2. A TS315 message is syntactically invalid
3. AIS forwards an IM917 Syntax Error Notification message to the Trader

Alt 2 - Pre-logged TSD is logically invalid

1. The process follows the core flow up to step 2
2. A TS315 message is logically invalid (Business rules violation)
3. AIS forwards a TS316 rejection message to the Trader

Alt 3 - Pre-logged TSD, 30 day timer expires

1. The process follows the core flow up to step 6
2. The 30-days timer has expired
3. AIS forwards a TS351 rejection message to the Trader

Alt 4 - Pre-logged TSD – Presentation Notification is syntactically invalid

1. The process follows the core flow up to step 7
2. A TS332 message is syntactically invalid
3. AIS forwards an IM917 Syntax Error Notification message to the Trader

Alt 5 - Pre-logged TSD presentation notification is logically invalid

1. The process follows the core flow up to step 8
2. A TS332 message is logically invalid (Business rules violation)
3. AIS forwards a TS333 rejection message to the Trader

Alt 6 - Pre-logged TSD, ETA Time Limit Exhausted

1. The process follows the core flow up to step 9
2. The ETA time limit is exhausted
3. AIS forwards a TS351 not released message to the Trader

Alt 7 – Not arrived declaration

1. The process follows the core flow up to step 10
2. The declaration is not arrived
3. AIS sends message TS333 Presentation notification rejection
4. Declaration is set to status [REGISTERED]

4.2.2 End of Temporary Storage (Reserved for future use)

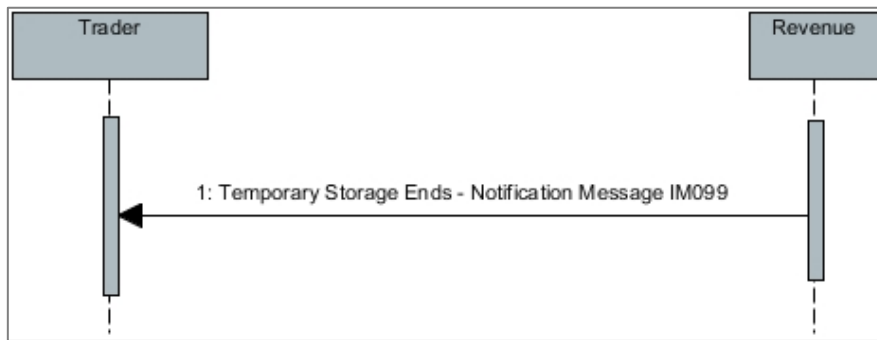

Core Flow (Happy Path) - End of Temporary Storage

1. Temporary Storage ends
2. AIS forwards an IM099 notification message to the Trader

4.2.3 Temporary Storage Declaration Amendment

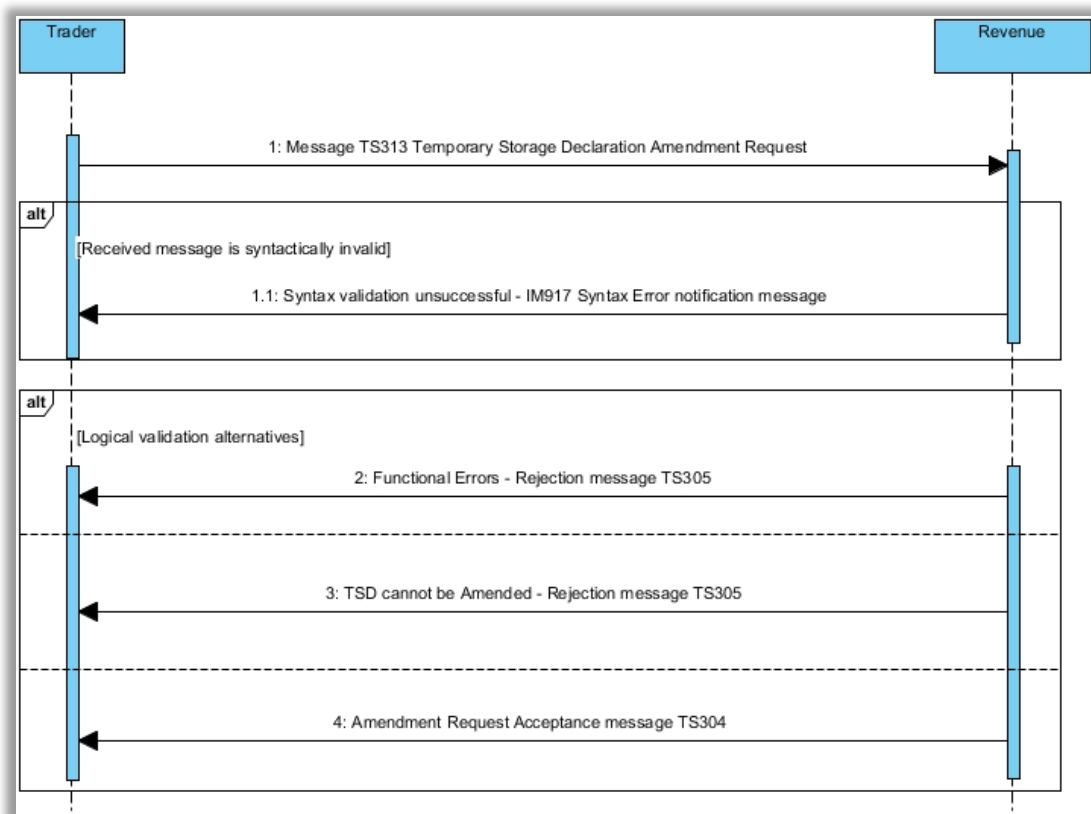

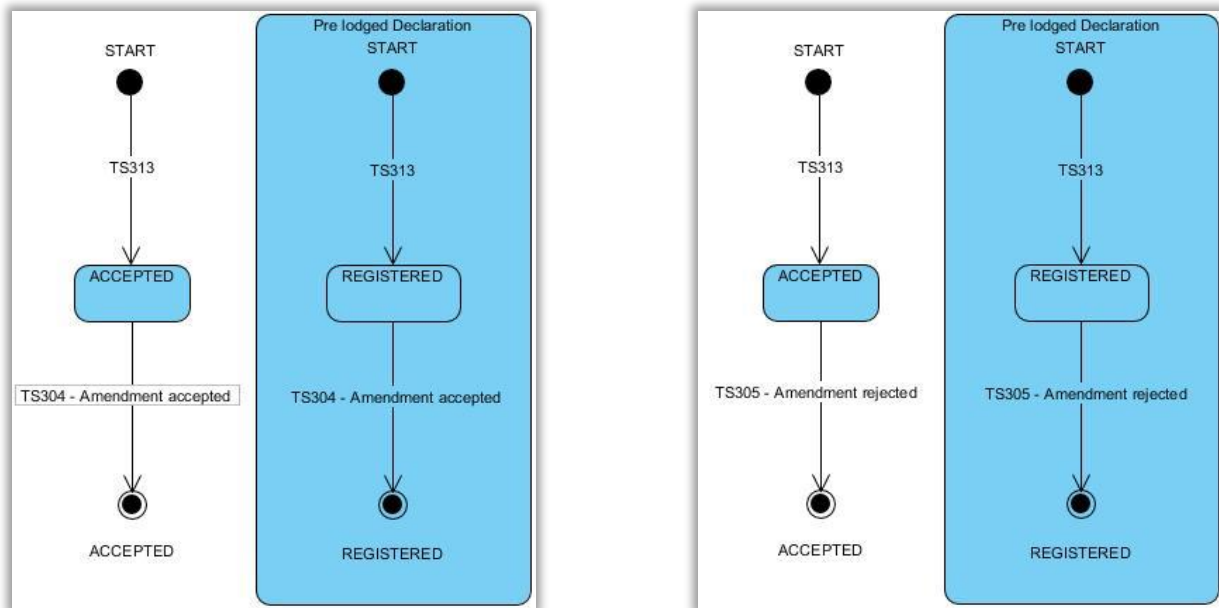

Core Flow (Happy Path) - Amendment request accepted

1. AIS receives a TS313 message
2. The message is syntactically valid
3. The message is logically valid (No business rules violation)
4. The Amendment request is accepted
5. AIS forwards a TS304 notification message to the Trader

Alt 1 - The Amendment request is syntactically invalid

1. The process follows the core flow up to step 1
2. The TS313 message is syntactically invalid
3. AIS forwards an IM917 Syntax Error Notification message to the Trader

Alt 2 - Amendment request rejected - functional errors

1. The process follows the core flow up to step 2
2. The TS313 message has functional errors
3. AIS forwards a TS305 rejection message to the Trader

Alt 3 - Amendment request rejected - TSD Cannot be amended

1. The process follows the core flow up to step 3
2. The TSD cannot be amended
3. AIS forwards a TS305 rejection message to the Trader

4.2.4 Temporary Storage Declaration Invalidation

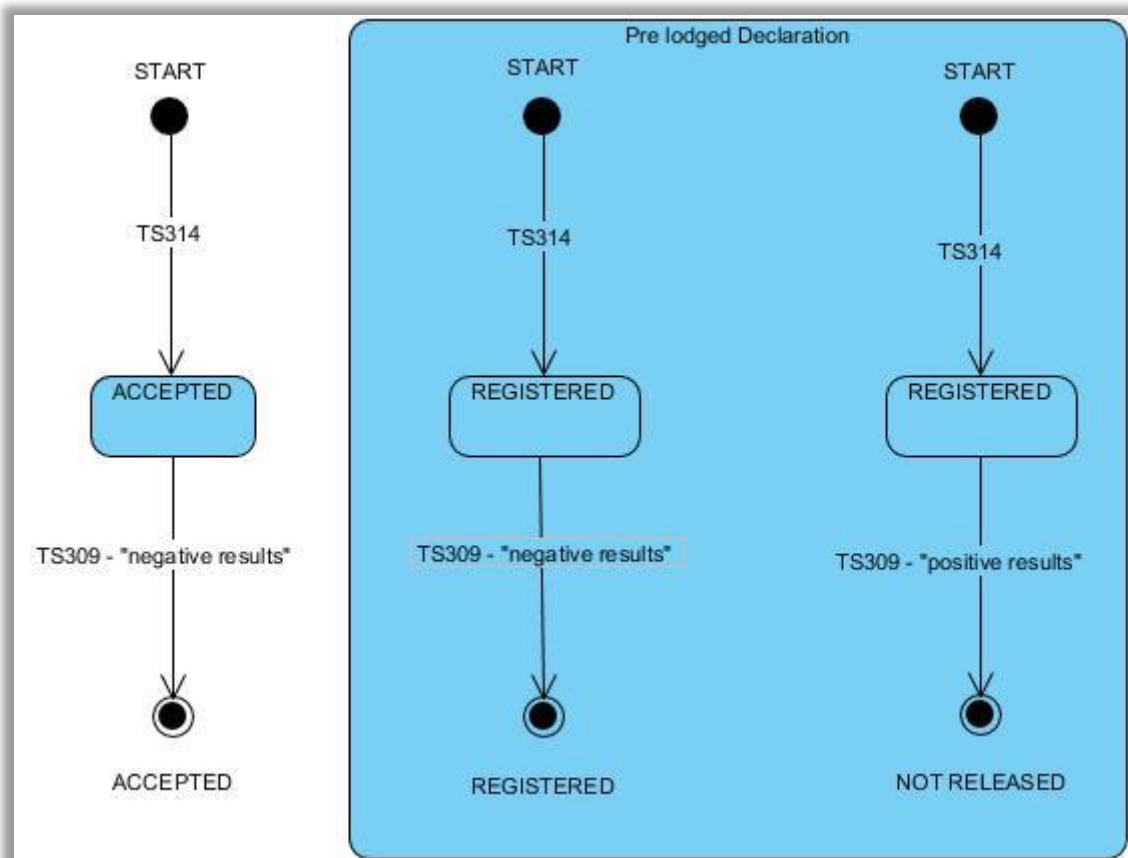
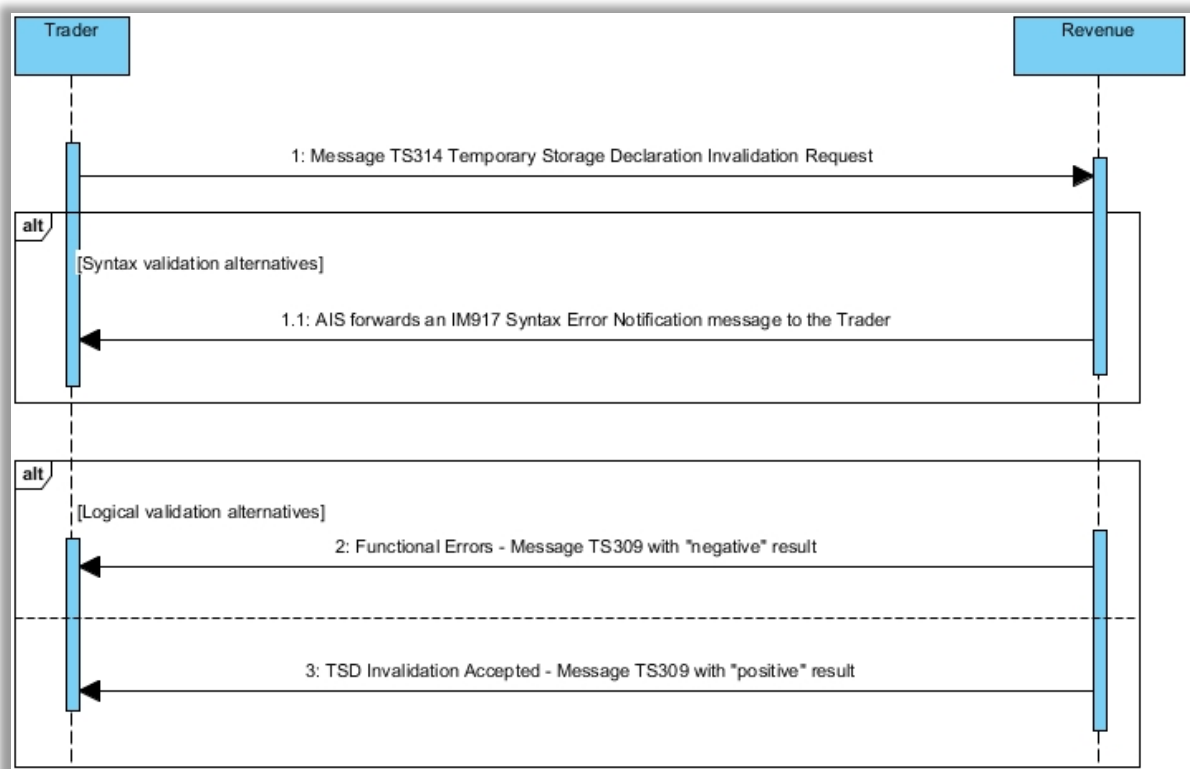

Core Flow (Happy Path) - Invalidation request accepted

1. AIS receives a TS314 message
2. The message is syntactically valid
3. The message is logically valid (No business rules violation)
4. The Invalidation request is accepted
5. AIS forwards a TS309 notification message to the Trader with “Positive” result

Alt 1 - The Invalidation request is syntactically invalid

1. The process follows the core flow up to step 1
2. A TS314 message is syntactically invalid
3. AIS forwards an IM917 Syntax Error Notification message to the Trader

Alt 2 – The Invalidation request is logically invalid

1. The process follows the core flow up to step 2
2. A TS314 message has logical validation errors or TSD cannot be invalidated
3. AIS forwards a TS309 notification message to the Trader with “Negative” result

5 Import - Release for free circulation

5.1 Messages

List of messages code and description that may be exchanged

ID	Description	Sent by
IM099	General Notification and Request Information message	AIS
IM917	Syntax Error notification message	AIS
Free Circulation		
IM404	Amendment Request Registration	AIS
IM405	Amendment Request Rejection	AIS
IM409	Invalidation Request Decision	AIS
IM413	Customs Declaration Amendment Request	TRADER
IM414	Invalidation Request	TRADER
IM415	Customs Declaration	TRADER
IM415V	Customs Declaration Acknowledgment	AIS
IM416	Customs Declaration Rejection	AIS
IM428	Customs Declaration Acceptance	AIS
IM429	Release Notification	AIS
IM432	Presentation Notification	TRADER
IM433	Presentation Notification Rejection	AIS
IM451	Release Rejection	AIS
IM460	Control Notice	AIS

5.2 Use Cases

5.2.1 Standard Customs Declarations

5.2.1.1 Standard Customs Declaration (H1, H5, H6, I1)

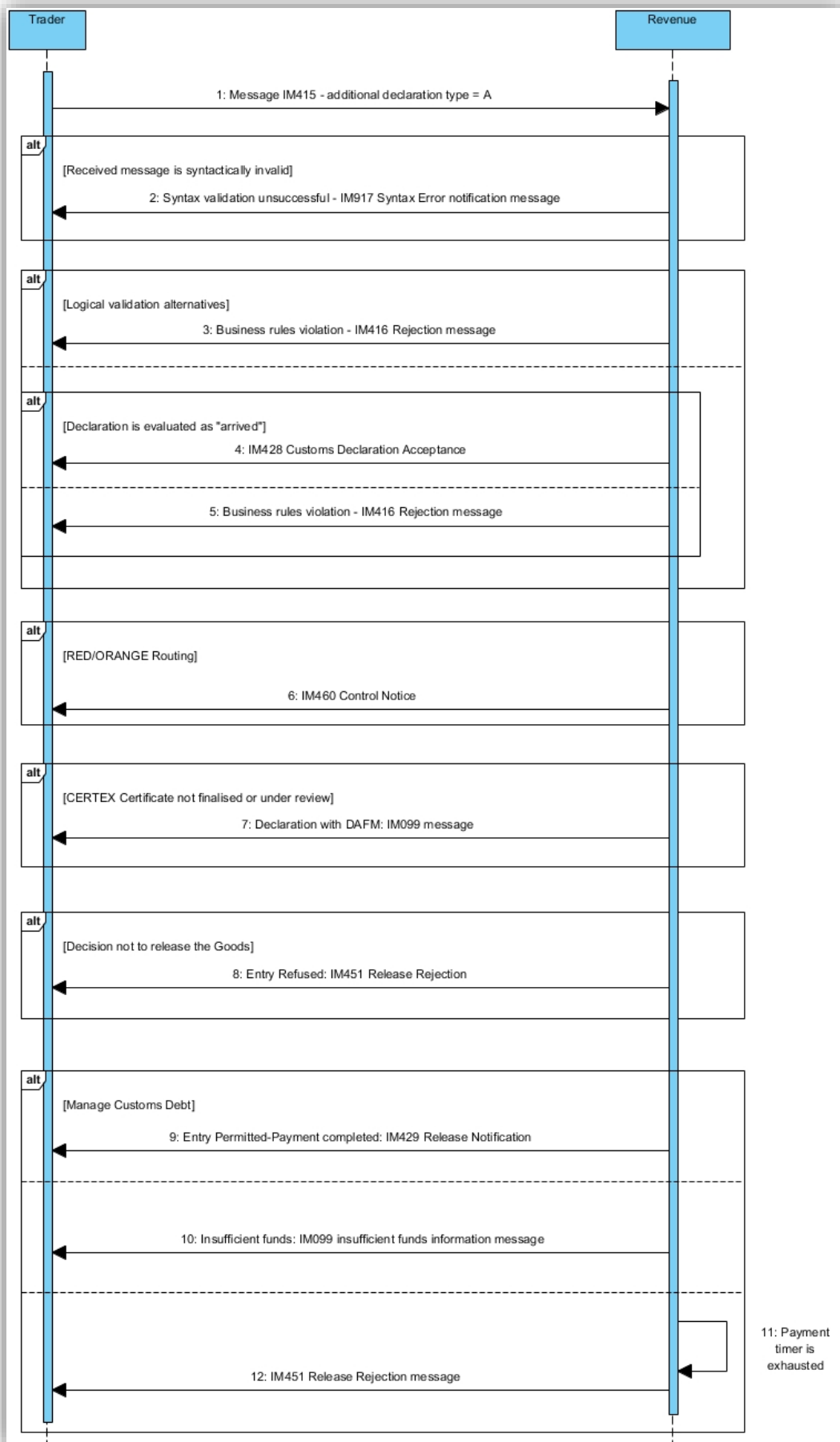

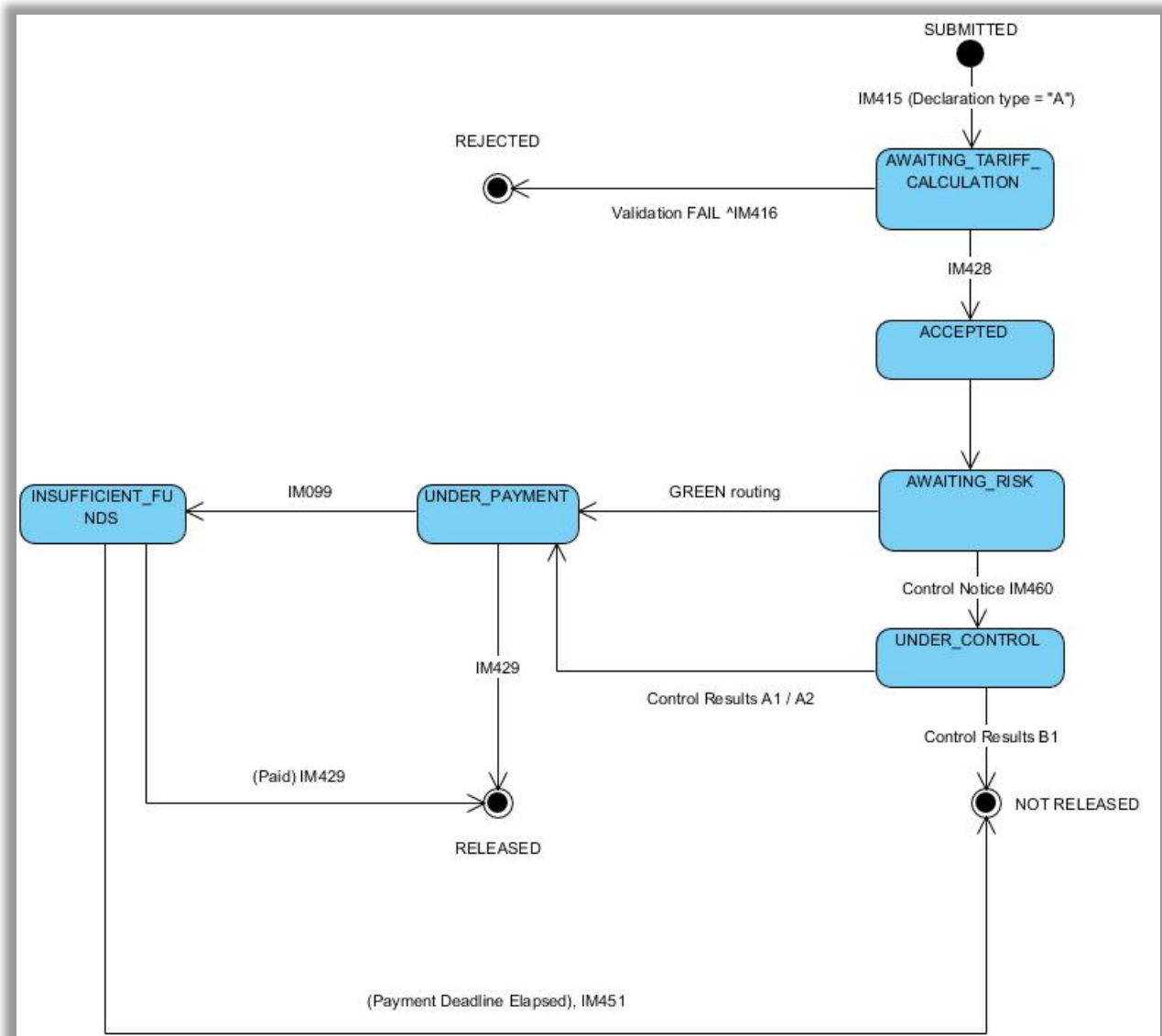

Core Flow (Happy Path) - Standard Customs Declaration

1. AIS receives an IM415 message (additional declaration type = A)
2. The message is syntactically valid
3. The message is logically valid (No business rules violation)
4. The declaration is evaluated as “arrived”
5. The declaration is accepted
6. AIS sends an IM428 acceptance message to the Trader
7. The declaration is Green routed

Alt 1 - The declaration is syntactically invalid

1. The process follows the Core Flow up to step 1
2. The IM415 message is syntactically invalid

3. AIS sends an IM917 Syntax Error message to the Trader

Alt 2 - The declaration is logically invalid

1. The process follows the Core Flow up to step 2
2. The IM415 message is logically invalid (Business rules violation)
3. AIS sends an IM416 rejection message to the Trader

Alt 3 – The declaration is evaluated as “non-arrived”

1. The process follows the Core Flow up to step 3
2. The declaration is evaluated as “non-arrived”
3. AIS sends an IM416 rejection message to the Trader

Alt 4 – RED/ORANGE Routing

1. The process follows the Core Flow up to step 6
2. The Declaration is Red/Orange routed
3. AIS sends an IM460 Control Notice message to the Trader

Alt 5 – CERTEX Certificate not finalised or under review

1. The process follows the core flow up to step 7
2. CERTEX reference is not finalised or under review
3. AIS sends IM099 “Declaration with DAFM” message to the Trader

Alt 6 - Decision to release the Goods - Entry Refused (Controls)

1. The process follows the Alt 4 up to step 3
2. The Goods cannot be released
3. AIS sends an IM451 release rejection message to the Trader

Alt 7 - Decision to release the Goods - Entry Permitted

1. The process follows the Core Flow up to step 7 or positive control results
2. The payment process is completed successfully
3. The Goods can be released
4. AIS sends an IM429 release notification message to the Trader

Alt 8 - Insufficient funds

1. The process follows the Core Flow up to step 7
2. Customs debt is due, Trader’s Revenue account has insufficient funds
3. AIS sends an IM099 “Insufficient funds” information message to the Trader

Alt 9 - Timer for payment expired

1. The process follows the Alt 8 up to step 3
2. Trader has failed to fulfil their financial obligation to Revenue within a specified time-limit
3. AIS sends an IM451 Release Rejection message to the Trader

5.2.1.2 Standard Customs Declaration (H7)

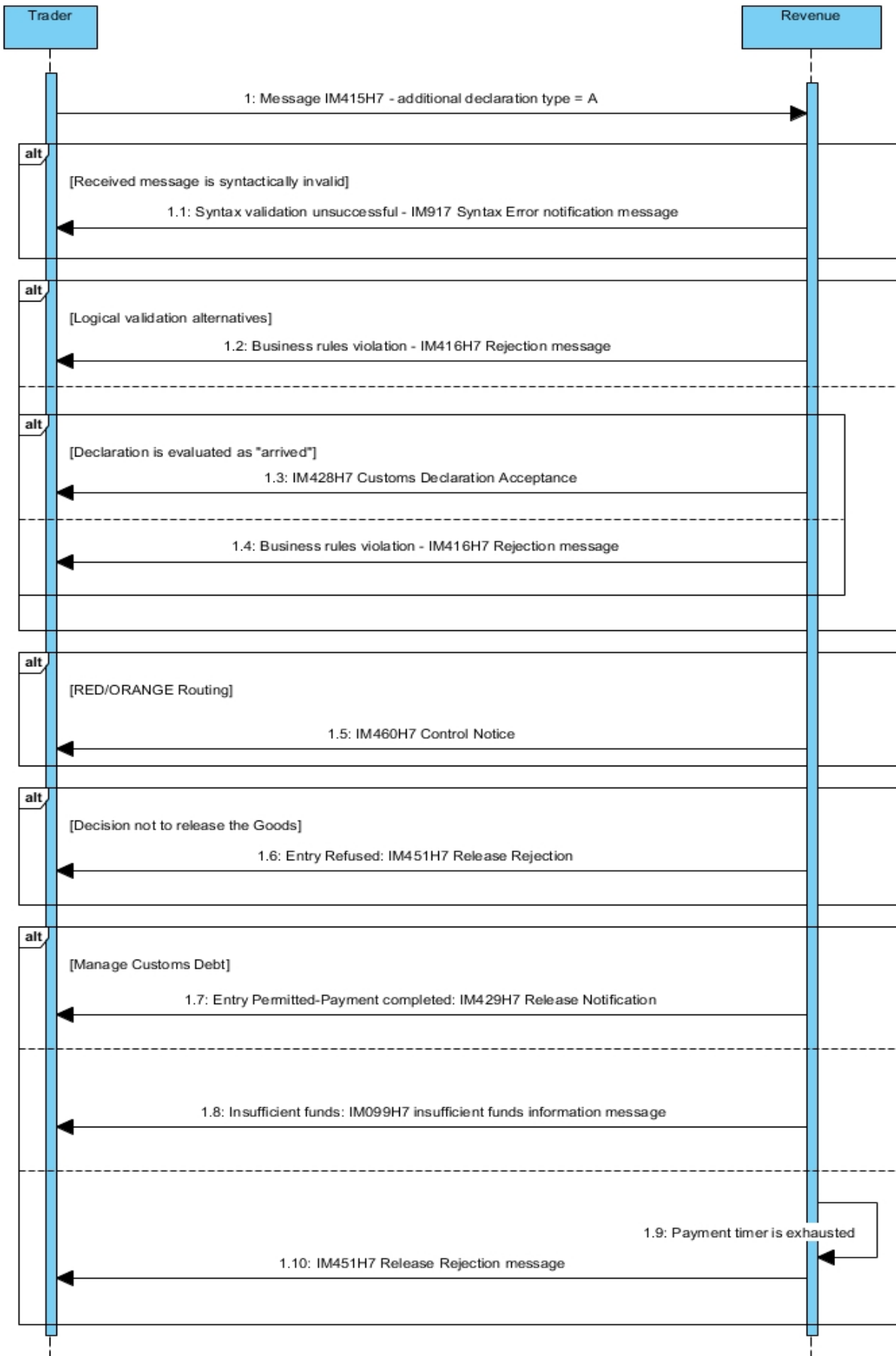

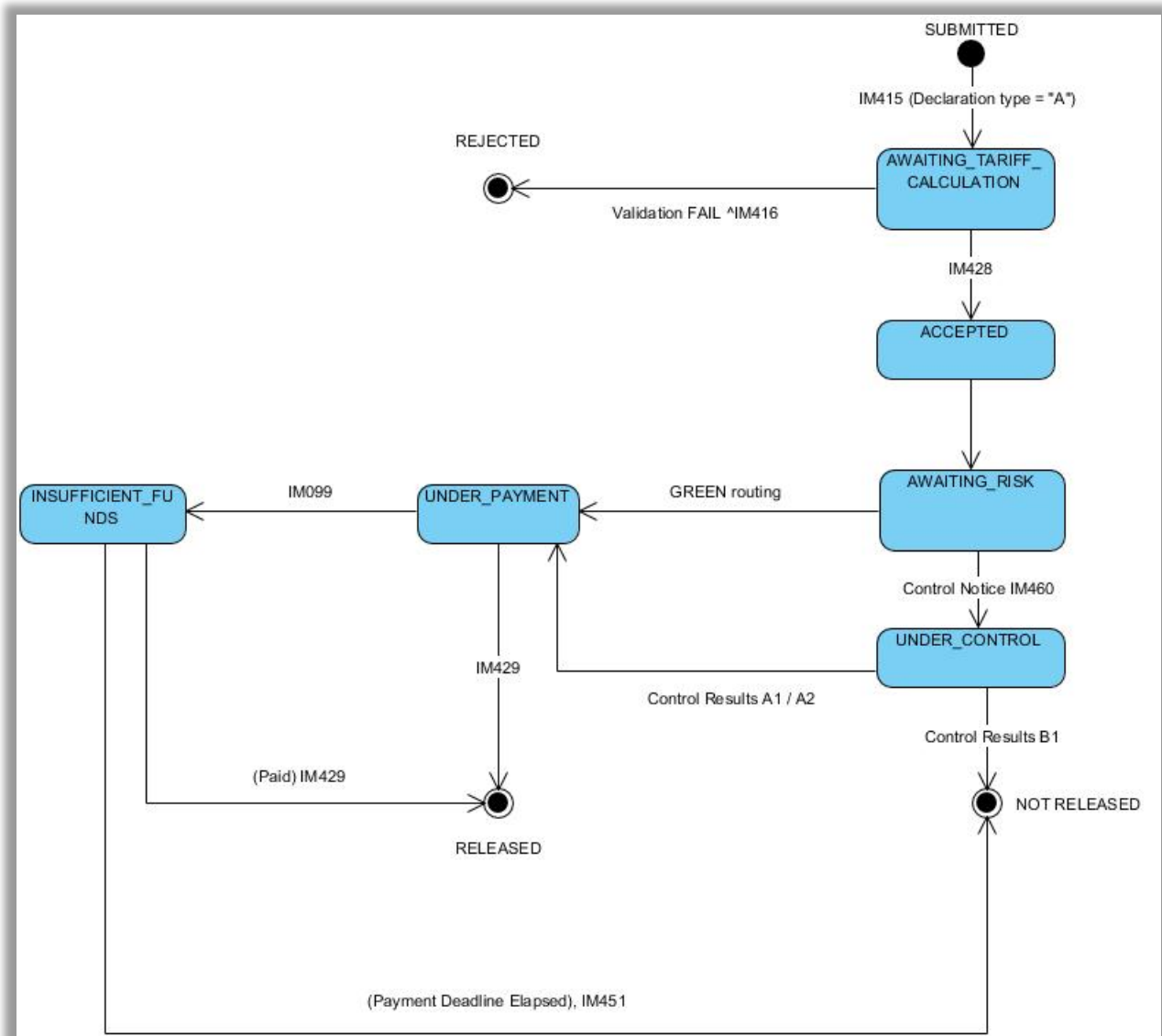

Core Flow (Happy Path) - Standard Customs Declaration

1. AIS receives an IM415H7 message (additional declaration type = A)
2. The message is syntactically valid
3. The message is logically valid (No business rules violation)
4. The declaration is evaluated as “arrived”
5. The declaration is accepted
6. AIS sends an IM428H7 acceptance message to the Trader
7. The declaration is Green routed

Alt 1 - The declaration is syntactically invalid

1. The process follows the Core Flow up to step 1
2. The IM415H7 message is syntactically invalid

3. AIS sends an IM917 Syntax Error message to the Trader

Alt 2 - The declaration is logically invalid

1. The process follows the Core Flow up to step 2
2. The IM415H7 message is logically invalid (Business rules violation)
3. AIS sends an IM416H7 rejection message to the Trader

Alt 3 – The declaration is evaluated as “non-arrived”

1. The process follows the Core Flow up to step 3
2. The declaration is evaluated as “non-arrived”
3. AIS sends an IM416H7 rejection message to the Trader

Alt 4 – RED/ORANGE Routing

1. The process follows the Core Flow up to step 6
2. The Declaration is Red/Orange routed
3. AIS sends an IM460H7 Control Notice message to the Trader

Alt 5 - Decision to release the Goods - Entry Refused (Controls)

1. The process follows the Alt 4 up to step 3
2. The Goods cannot be released
3. AIS sends an IM451H7 release rejection message to the Trader

Alt 6 - Decision to release the Goods - Entry Permitted

1. The process follows the Core Flow up to step 7 or positive control results
2. The payment process is completed successfully
3. The Goods can be released
4. AIS sends an IM429H7 release notification message to the Trader

Alt 7 - Insufficient funds

1. The process follows the Core Flow up to step 7
2. Customs debt is due, Trader’s Revenue account has insufficient funds
3. AIS sends an IM099H7 “Insufficient funds” information message to the Trader

Alt 8 - Timer for payment expired

1. The process follows the Alt 8 up to step 3
2. Trader has failed to fulfil their financial obligation to Revenue within a specified time-limit
3. AIS sends an IM451H7 Release Rejection message to the Trader

5.2.2 Pre-lodged Standard Customs Declarations

5.2.2.1 Pre-lodged Standard Customs Declaration (H1, H6, I1)

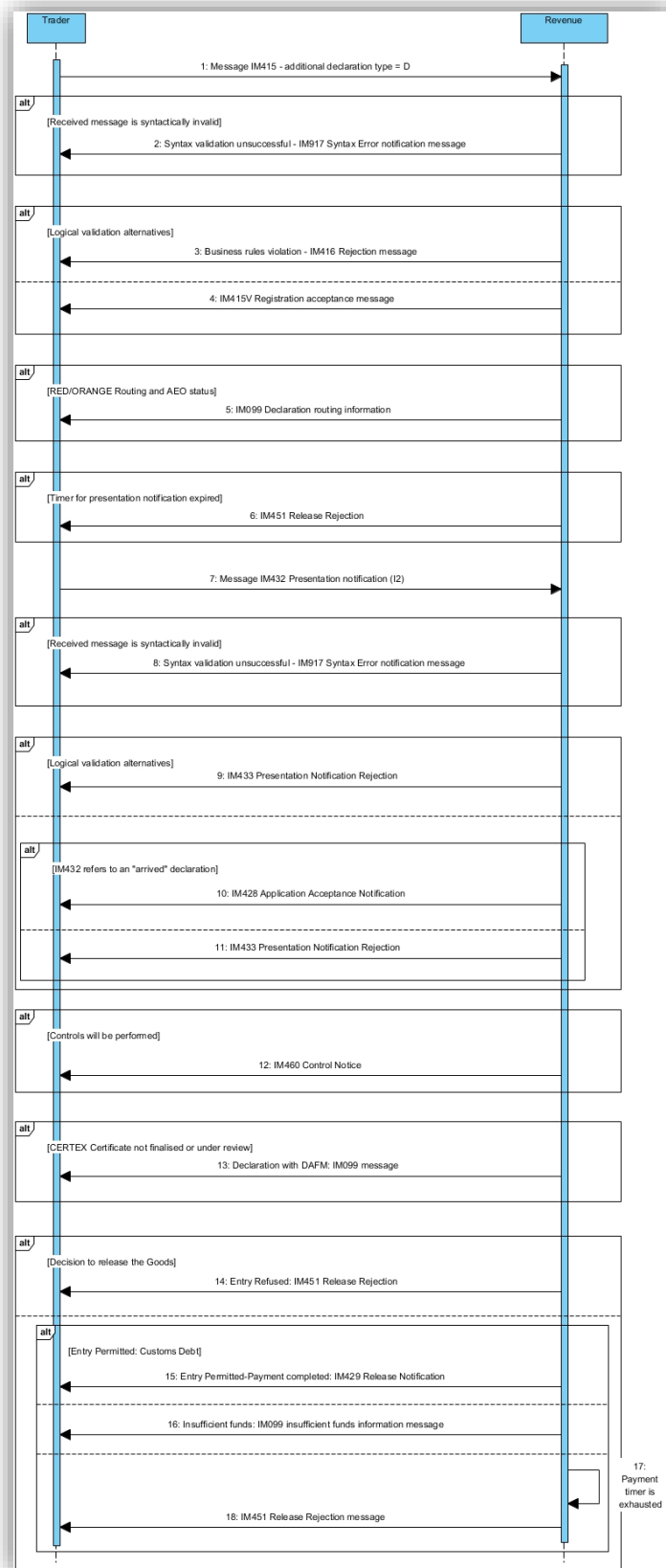

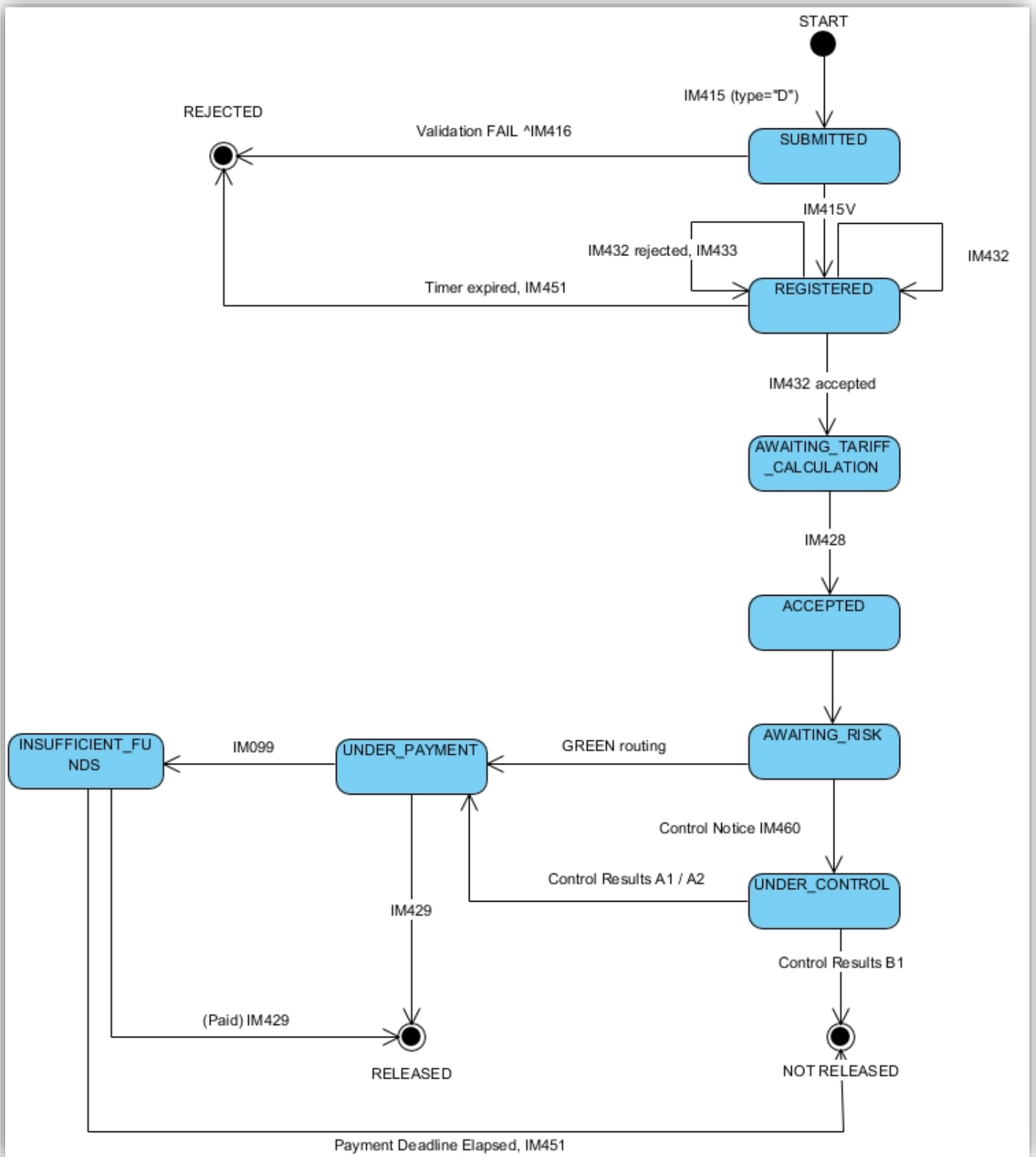

Core Flow (Happy Path) - Pre-logged Standard Customs Declaration

1. AIS receives an IM415 message (additional declaration type = D)
2. The IM415 message is syntactically valid
3. The IM415 message is logically valid (No business rules violation)
4. AIS forwards an IM415V Customs Declaration Acknowledgment message to the Trader
5. The declaration is Green routed
6. AIS receives the IM432 message
7. The IM432 message is syntactically valid
8. The IM432 message is logically valid (No business rules violation)
9. The IM432 message refers to an “arrived” declaration
10. AIS forwards an IM428 acceptance message to the Trader

Alt 1 - The declaration is syntactically invalid

1. The process follows the Core Flow up to step 1
2. The IM415 message is syntactically invalid
3. AIS forwards an IM917 Syntax Error Notification message to the Trader

Alt 2 - The declaration is logically invalid

1. The process follows the Core Flow up to step 2
2. The message is logically invalid (Business rules violation)
3. AIS forwards an IM416 rejection message to the Trader

Alt 3 – RED/ORANGE Routing

1. The process follows the Core Flow up to step 4
2. The Declaration is Orange/Red routed
3. AIS forwards an IM099 advanced routing information to the declaration Importer if AEO

Alt 4 - Timer for presentation notification expired

1. The process follows the Core Flow up to step 5
2. The timer for Presentation Notification expires
3. AIS forwards an IM451 message to the Trader

Alt 5 - The presentation notification is syntactically invalid

1. The process follows the Core Flow up to step 6
2. The IM432 message is syntactically invalid
3. AIS forwards an IM917 Syntax Error Notification message to the Trader

Alt 6 – Logically invalid presentation notification

1. The process follows the Core Flow up to step 7
2. The IM432 is logically invalid (Business rules violation)
3. AIS forwards an IM433 rejection message to the Trader

Alt 7 – IM432 refers to a “non-arrived” declaration

1. The process follows the core flow up to step 8

2. The IM432 message refers to a “non-arrived” declaration
3. AIS forwards an IM433 rejection message to the Trader

Alt 8 - Controls will be performed (Goods presented)

1. The process follows the Alt 3 up to step 3
2. AIS forwards an IM460 Control Notice message to the Trader

Alt 9 – CERTEX Certificate not finalised or under review

1. The process follows the core flow up to step 9
2. CERTEX reference is not finalised or under review
3. AIS sends IM099 “Declaration with DAFM” message

Alt 10 - Decision to release the Goods - Entry Refused (Controls)

1. The process follows the Alt 8 up to step 2
2. The Goods cannot be released
3. AIS forwards an IM451 release rejection message to the Trader

Alt 11 - Decision to release the Goods - Entry Permitted

1. The process follows the Core Flow up to step 10 or positive control results
2. The payment process is completed successfully
3. The Goods can be released
4. AIS forwards an IM429 release notification message to the Trader

Alt 12 - Insufficient funds

1. The process follows the Core Flow up to step 10
2. Customs debt is due, Trader’s Revenue account has insufficient funds
3. AIS forwards an IM099 “insufficient funds” information message

Alt 13 - Timer for payment expired

1. The process follows the Alt 12 up to step 3
2. Trader has failed to fulfil their financial obligation to Revenue within a specified time-limit
3. AIS forwards an IM451 Release Rejection message

Alt 14 – Tariff validation or calculation error after arrival and presentation

1. The process follows the Core Flow up to step 9
2. An error is detected during the Tariff calculation.
3. Depending on the error, AIS forwards an IM416 Customs Declaration Rejection or an IM451 Release Rejection message.

5.2.2.2 Pre-lodged Standard Customs Declaration (H7)

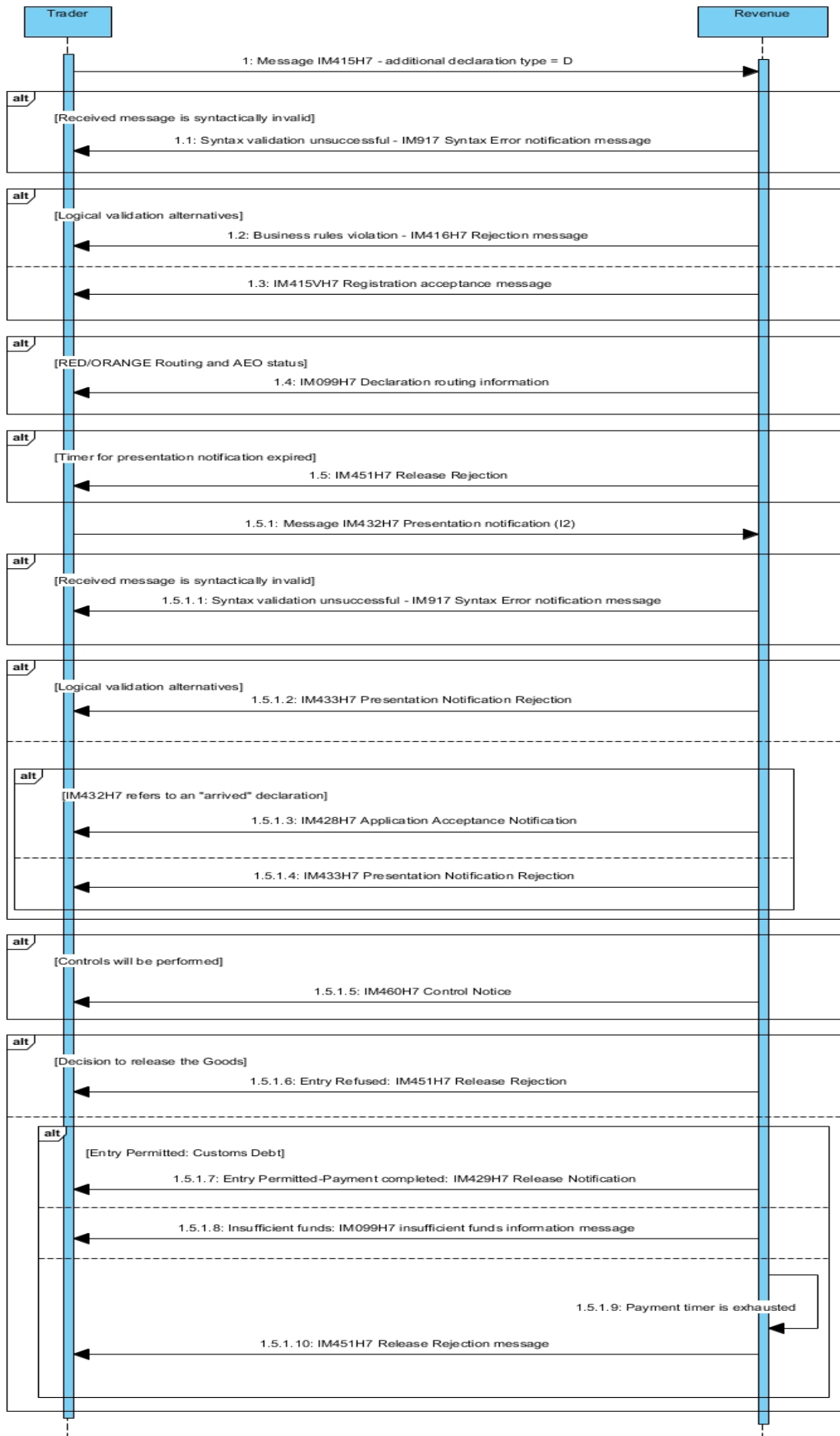

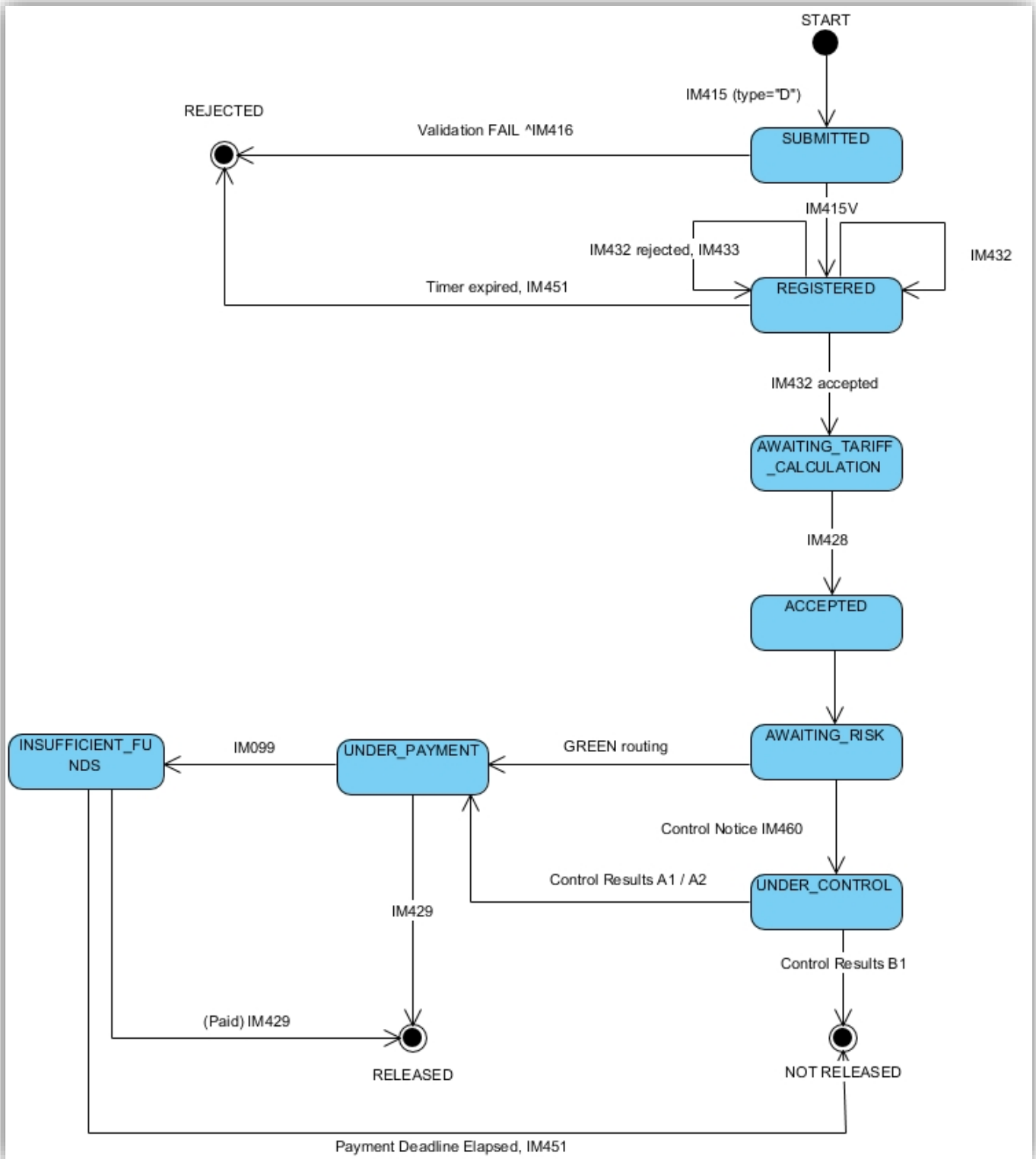

Core Flow (Happy Path) - Pre-logged Standard Customs Declaration

1. AIS receives an IM415H7 message (additional declaration type = D)
2. The IM415H7 message is syntactically valid
3. The IM415H7 message is logically valid (No business rules violation)
4. AIS forwards an IM415VH7 Customs Declaration Acknowledgment message to the Trader
5. The declaration is Green routed
6. AIS receives the IM432H7 message
7. The IM432H7 message is syntactically valid
8. The IM432H7 message is logically valid (No business rules violation)
9. The IM432H7 message refers to an “arrived” declaration
10. AIS forwards an IM428H7 acceptance message to the Trader

Alt 1 - The declaration is syntactically invalid

1. The process follows the Core Flow up to step 1
2. The IM415H7 message is syntactically invalid
3. AIS forwards an IM917 Syntax Error Notification message to the Trader

Alt 2 - The declaration is logically invalid

1. The process follows the Core Flow up to step 2
2. The message is logically invalid (Business rules violation)
3. AIS forwards an IM416H7 rejection message to the Trader

Alt 3 – RED/ORANGE Routing

1. The process follows the Core Flow up to step 4
2. The Declaration is Orange/Red routed
3. AIS forwards an IM099H7 advanced routing information to the declaration Importer if AEO

Alt 4 - Timer for presentation notification expired

1. The process follows the Core Flow up to step 5
2. The timer for Presentation Notification expires
3. AIS forwards an IM451H7 message to the Trader

Alt 5 - The presentation notification is syntactically invalid

1. The process follows the Core Flow up to step 6
2. The IM432H7 message is syntactically invalid
3. AIS forwards an IM917 Syntax Error Notification message to the Trader

Alt 6 – Logically invalid presentation notification

1. The process follows the Core Flow up to step 7
2. The IM432H7 is logically invalid (Business rules violation)
3. AIS forwards an IM433H7 rejection message to the Trader

Alt 7 – IM432H7 refers to a “non-arrived” declaration

1. The process follows the core flow up to step 8

2. The IM432H7 message refers to a “non-arrived” declaration
3. AIS forwards an IM433H7 rejection message to the Trader

Alt 8 - Controls will be performed (Goods presented)

1. The process follows the Alt 3 up to step 3
2. AIS forwards an IM460H7 Control Notice message to the Trader

Alt 9 - Decision to release the Goods - Entry Refused (Controls)

1. The process follows the Alt 8 up to step 2
2. The Goods cannot be released
3. AIS forwards an IM451H7 release rejection message to the Trader

Alt 10 - Decision to release the Goods - Entry Permitted

1. The process follows the Core Flow up to step 10 or positive control results
2. The payment process is completed successfully
3. The Goods can be released
4. AIS forwards an IM429H7 release notification message to the Trader

Alt 11 - Insufficient funds

1. The process follows the Core Flow up to step 10
2. Customs debt is due, Trader’s Revenue account has insufficient funds
3. AIS forwards an IM099H7 “insufficient funds” information message

Alt 12 - Timer for payment expired

1. The process follows the Alt 12 up to step 3
2. Trader has failed to fulfil their financial obligation to Revenue within a specified time-limit
3. AIS forwards an IM451H7 Release Rejection message

Alt 13 – Tariff validation or calculation error after arrival and presentation

1. The process follows the Core Flow up to step 9
2. An error is detected during the Tariff calculation.
3. Depending on the error, AIS forwards an IM416 Customs Declaration Rejection or an IM451 Release Rejection message.

5.2.3 Simplified Customs Declaration

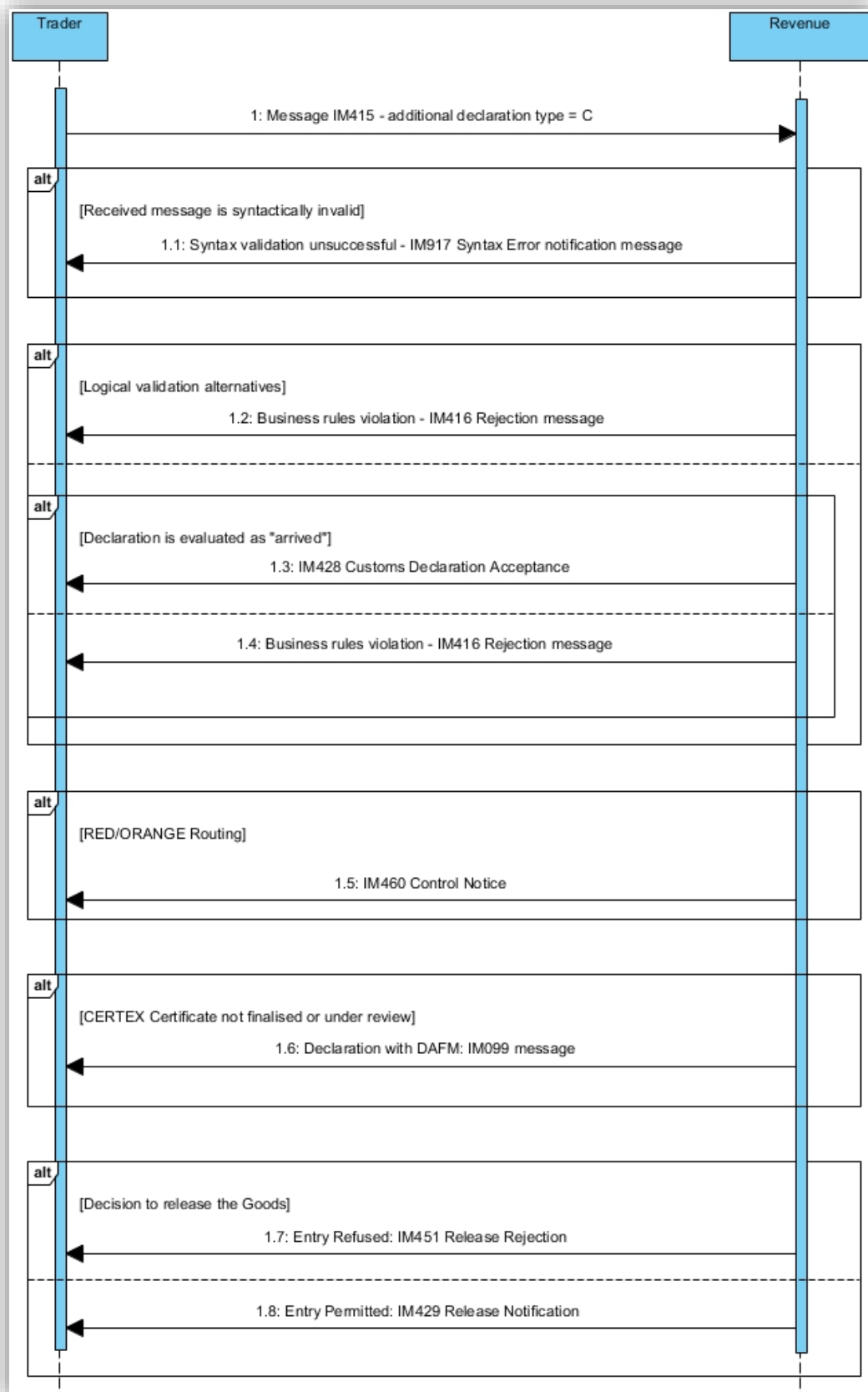

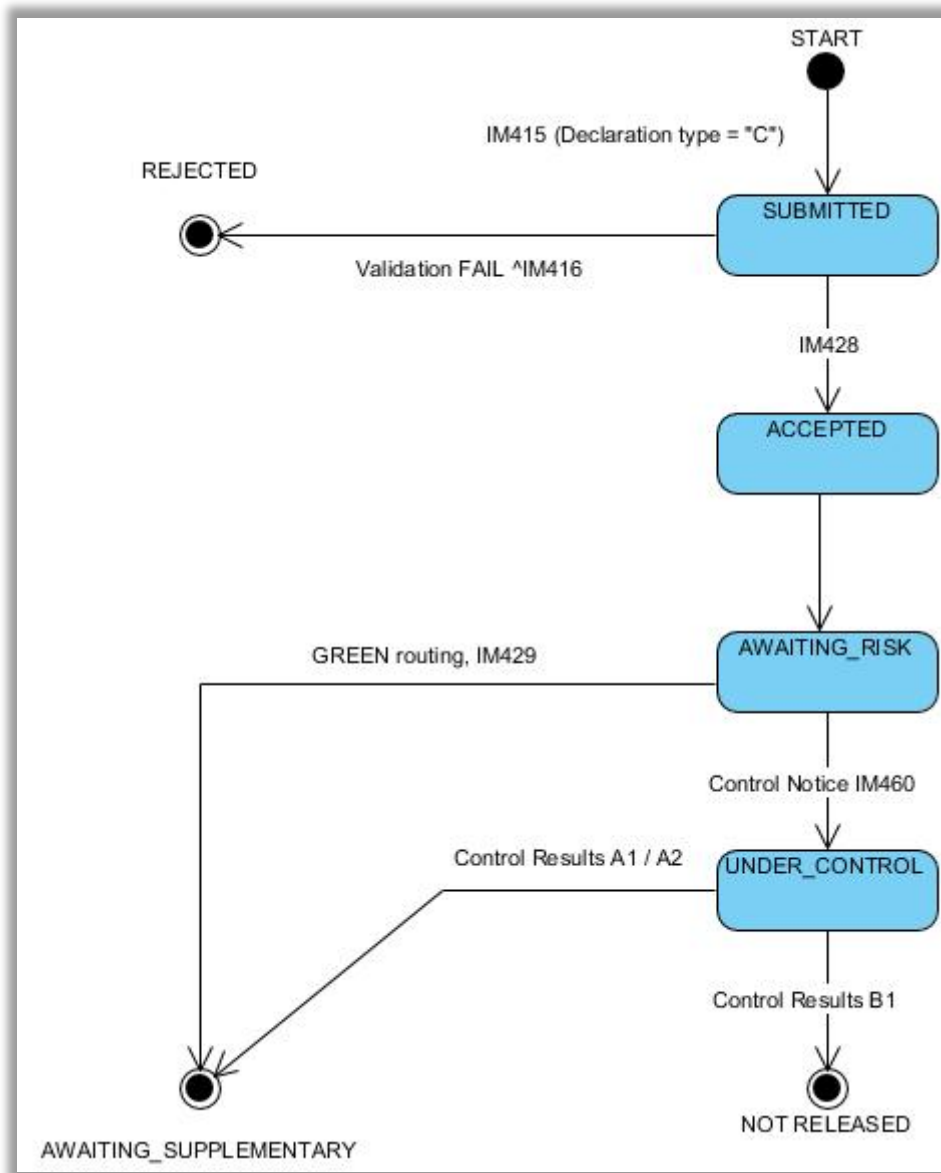

Preconditions

A simplified declaration (IM415) with additional declaration type C or F **WITHOUT** consignment level **DE 2/2 Code = N9000** (No supplementary waiver code)

Core Flow (Happy Path) - Simplified Customs Declaration

1. AIS receives an IM415 message (additional declaration type = C)
2. The message is syntactically valid
3. The message is logically valid (No business rules violation)
4. Declaration is evaluated as “arrived”
5. AIS forwards an IM428 acceptance message to the Trader
6. The declaration is Green routed

Alt 1 - The declaration is syntactically invalid

1. The process follows the Core Flow up to step 1

2. The IM415 message is syntactically invalid
3. AIS forwards an IM917 Syntax Error Notification message to the Trader

Alt 2 - The declaration is logically invalid

1. The process follows the Core Flow up to step 2
2. The message is logically invalid (Business rules violation)
3. AIS forwards an IM416 rejection message to the Trader

Alt 3 – Declaration is evaluated as “non-arrived”

1. The process follows the Core Flow up to step 3
2. Declaration is evaluated as “non-arrived”
3. AIS forwards an IM416 rejection message to the Trader

Alt 4 – RED/ORANGE Routing

1. The process follows the Core Flow up to step 5
2. The Declaration is Orange/Red routed
3. AIS forwards an IM460 Control Notice message to the Trader

Alt 5 – CERTEX Certificate not finalised or under review

1. The process follows the core flow up to step 6
2. CERTEX reference is not finalised or under review
3. AIS sends IM099 “Declaration with DAFM” message to the Trader

Alt 6 - Decision to release the Goods - Entry Refused (Controls)

1. The process follows the Alt 4 up to step 3
2. The Goods cannot be released
3. AIS forwards an IM451 release rejection message to the Trader

Alt 7 – Decision to release the Goods – Entry Permitted

1. The process follows the Core Flow up to step 6 or positive control results
2. The Goods can be released
3. AIS forwards an IM429 release permitted message to the Trader

5.2.4 Simplified Customs Declaration with Supplementary Waiver

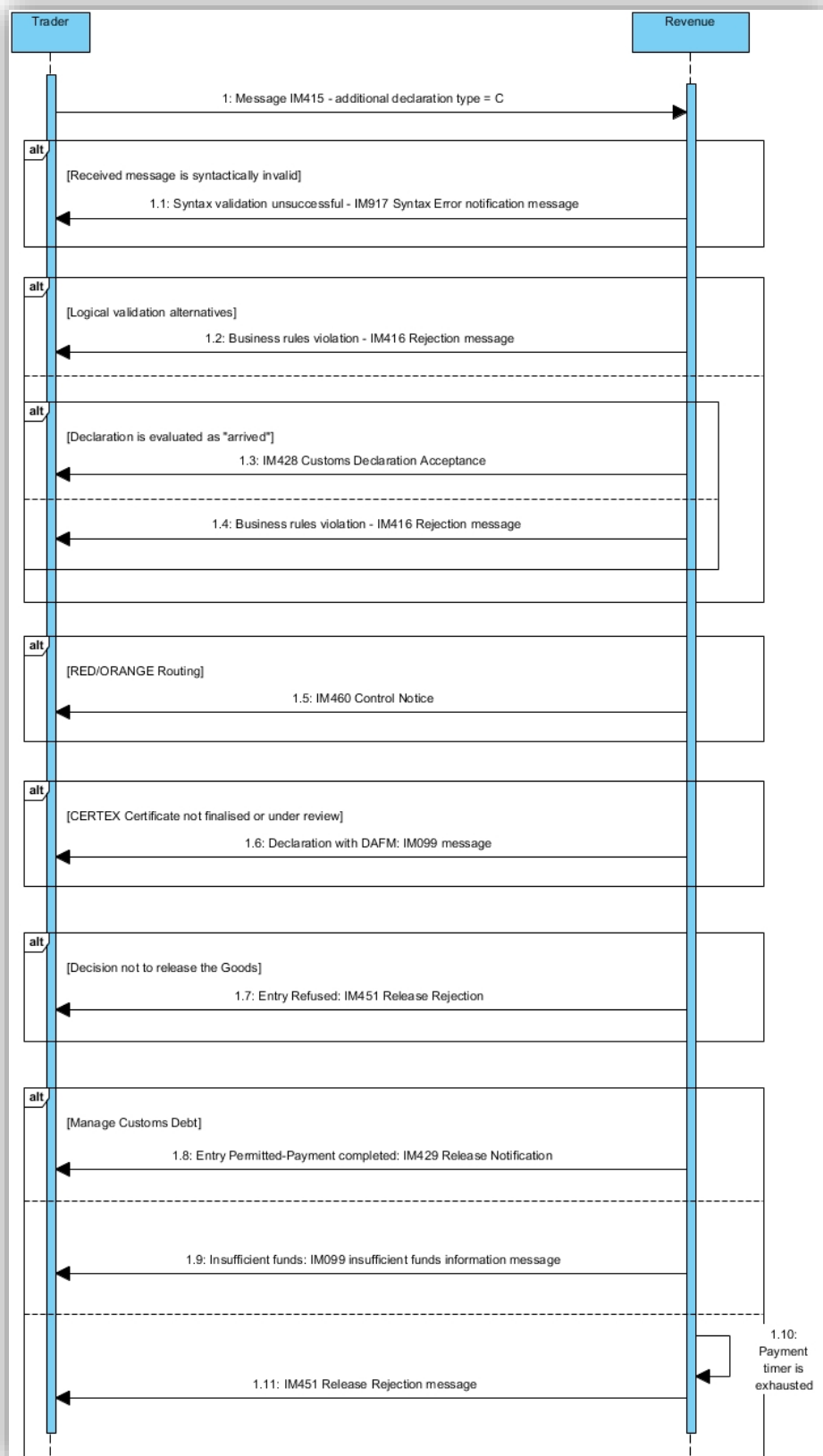

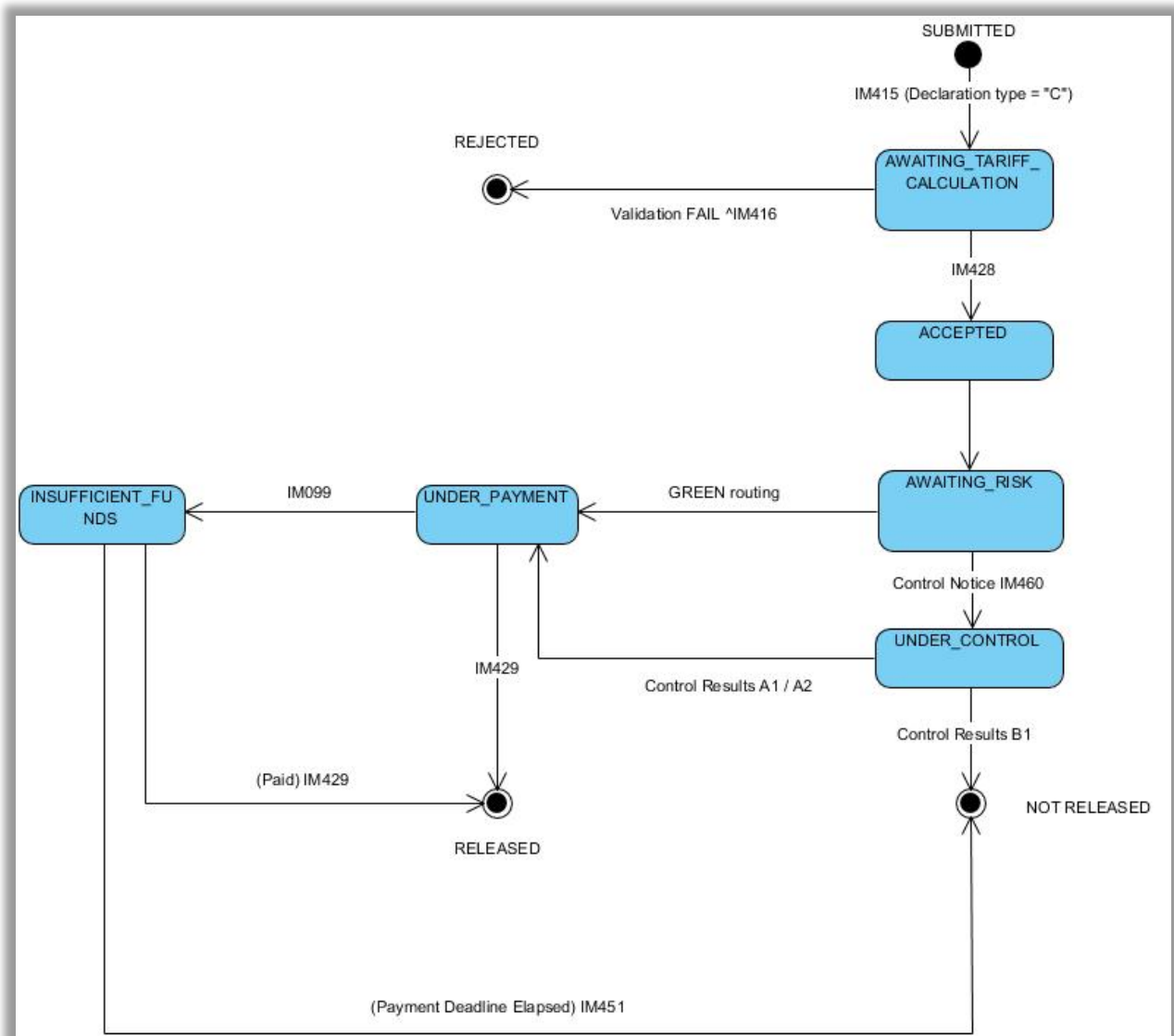

Core Flow (Happy Path) - Simplified Customs Declaration with Supplementary Waiver (Code N9000 in DE 2/3)

1. AIS receives an IM415 message (additional declaration type = C)
2. The message is syntactically valid
3. The message is logically valid (No business rules violation)
4. The declaration is evaluated as arrived
5. The declaration is accepted
6. AIS sends an IM428 acceptance message to the Trader
7. The declaration is Green routed

Alt 1 - The declaration is syntactically invalid

1. The process follows the Core Flow up to step 1
2. The IM415 message is syntactically invalid

3. AIS sends an IM917 Syntax Error message to the Trader

Alt 2 - The declaration is logically invalid

1. The process follows the Core Flow up to step 2
2. The IM415 message is logically invalid (Business rules violation)
3. AIS sends an IM416 rejection message to the Trader

Alt 3 – The declaration is evaluated as “non-arrived”

1. The process follows the Core Flow up to step 3
2. The declaration is evaluated as “non-arrived”
3. AIS sends an IM416 rejection message to the Trader

Alt 4 – RED/ORANGE Routing

1. The process follows the Core Flow up to step 6
2. The Declaration is Red/Orange routed
3. AIS sends an IM460 Control Notice message to the Trader

Alt 5 – CERTEX Certificate not finalised or under review

1. The process follows the core flow up to step 7
2. CERTEX reference is not finalised or under review
3. AIS sends IM099 “Declaration with DAFM” message to the Trader

Alt 6 - Decision to release the Goods - Entry Refused (Controls)

1. The process follows the Alt 4 up to step 3
2. The Goods cannot be released
3. AIS sends an IM451 release rejection message to the Trader

Alt 7 - Decision to release the Goods - Entry Permitted

1. The process follows the Core Flow up to step 7 or positive control results
2. The payment process is completed successfully
3. The Goods can be released
4. AIS sends an IM429 release notification message to the Trader

Alt 8 - Insufficient funds

1. The process follows the Core Flow up to step 7
2. Customs debt is due, Trader’s Revenue account has insufficient funds
3. AIS sends an IM099 “Insufficient funds” information message to the Trader

Alt 9 - Timer for payment expired

1. The process follows the Alt 8 up to step 3
2. Trader has failed to fulfil their financial obligation to Revenue within a specified time-limit
3. AIS sends an IM451 Release Rejection message to the Trader

5.2.5 Pre-Lodged Simplified Customs Declaration

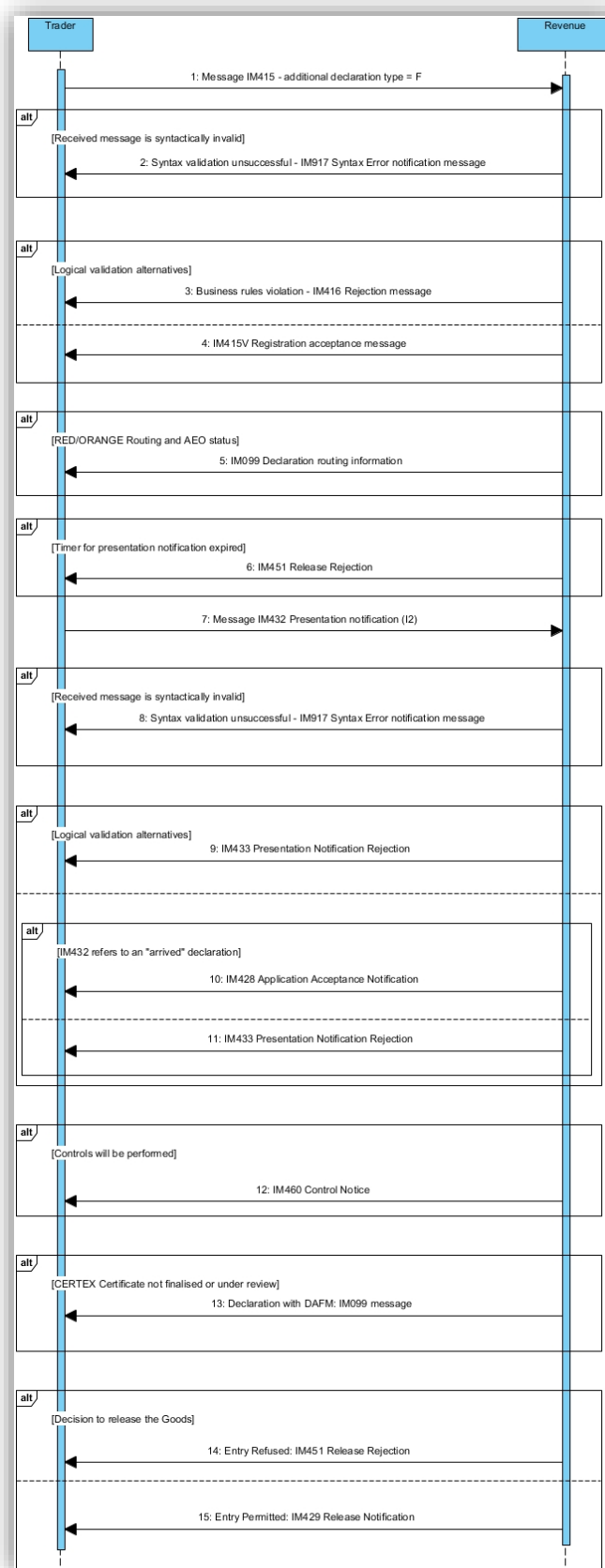

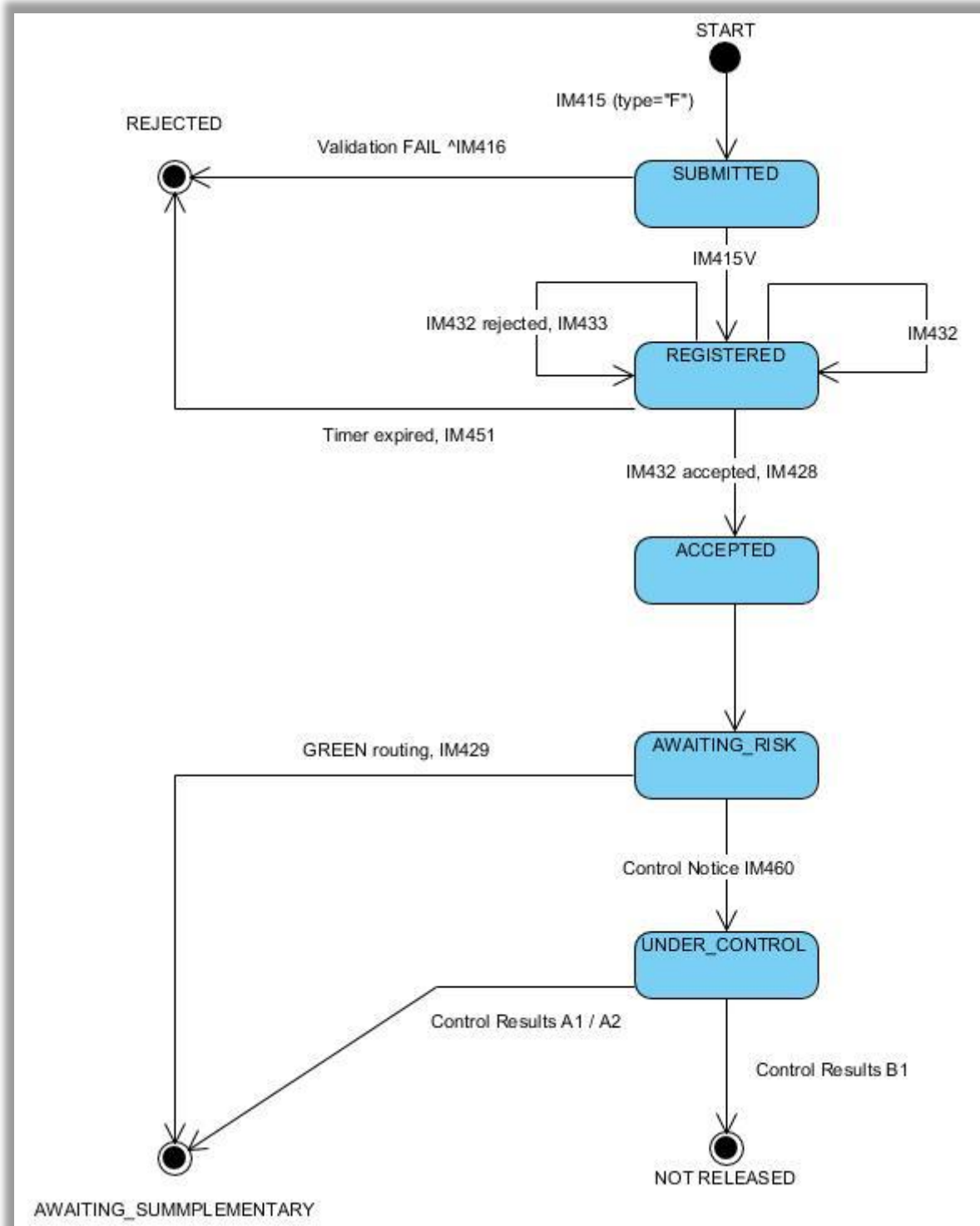

Preconditions

A simplified declaration (IM415) with additional declaration type F **WITHOUT** supplementary waiver (consignment level **DE 2/2** Code = N9000)

Core Flow (Happy Path) - Pre-lodged Simplified Declaration

1. AIS receives an IM415 message (additional declaration type = F)

2. The message is syntactically valid
3. The message is logically valid (No business rules violation)
4. AIS forwards an IM415V Customs Declaration Acknowledgment (Registration) message to the Trader
5. The declaration is Green routed
6. AIS receives the IM432 message
7. The message is syntactically valid
8. The message is logically valid (No business rules violation)
9. IM432 refers to an “arrived” declaration
10. AIS forwards an IM428 acceptance message to the Trader

Alt 1 - The declaration is syntactically invalid

1. The process follows the Core Flow up to step 1
2. The IM415 message is syntactically invalid
3. AIS forwards an IM917 Syntax Error Notification message to the Trader

Alt 2 - The declaration is logically invalid

1. The process follows the Core Flow up to step 2
2. The message is logically invalid (Business rules violation)
3. AIS forwards an IM416 rejection message to the Trader

Alt 3 – RED/ORANGE Routing

1. The process follows the Core Flow up to step 4
2. The Declaration is Orange/Red routed
3. AIS forwards an IM099 declaration routing information to the declaration Importer if AEO

Alt 4 - Timer for presentation notification expired

1. The process follows the Core Flow up to step 5
2. The timer for Presentation Notification expires
3. AIS forwards an IM451 message to the Trader

Alt 5 - The presentation notification is syntactically invalid

1. The process follows the Core Flow up to step 6
2. The IM432 message is syntactically invalid
3. AIS forwards an IM917 Syntax Error Notification message to the Trader

Alt 6 - Invalid presentation notification

1. The process follows the Core Flow up to step 7
2. The message is logically invalid (Business rules violation)
3. AIS forwards an IM433 rejection message to the Trader

Alt 7 – IM432 refers to a “non-arrived” declaration

1. The process follows the core flow up to step 8
2. IM432 refers to a “non-arrived” declaration
3. AIS forwards an IM433 rejection message to the Trader

Alt 8 - Controls will be performed

1. The process follows the Alt 3 up to step 3
2. AIS forwards an IM460 Control Notice message to the Trader

Alt 9 – CERTEX reference not finalised or under review

1. The process follows the core flow up to step 10
2. CERTEX reference is not finalised or under review
3. AIS sends IM099 “Declaration with DAFM” message to the Trader

Alt 10 - Decision to release the Goods - Entry Refused (Controls)

1. The process follows the Alt 8 up to step 2
2. The Goods cannot be released
3. AIS forwards an IM451 release rejection message to the Trader

Alt 11 - Decision to release the Goods - Entry Permitted

1. The process follows the Core Flow up to step 9 or positive control results
2. The Goods can be released
3. AIS forwards an IM429 release notification message to the Trader

5.2.6 Pre-Lodged Simplified Customs Declaration with supplementary waiver

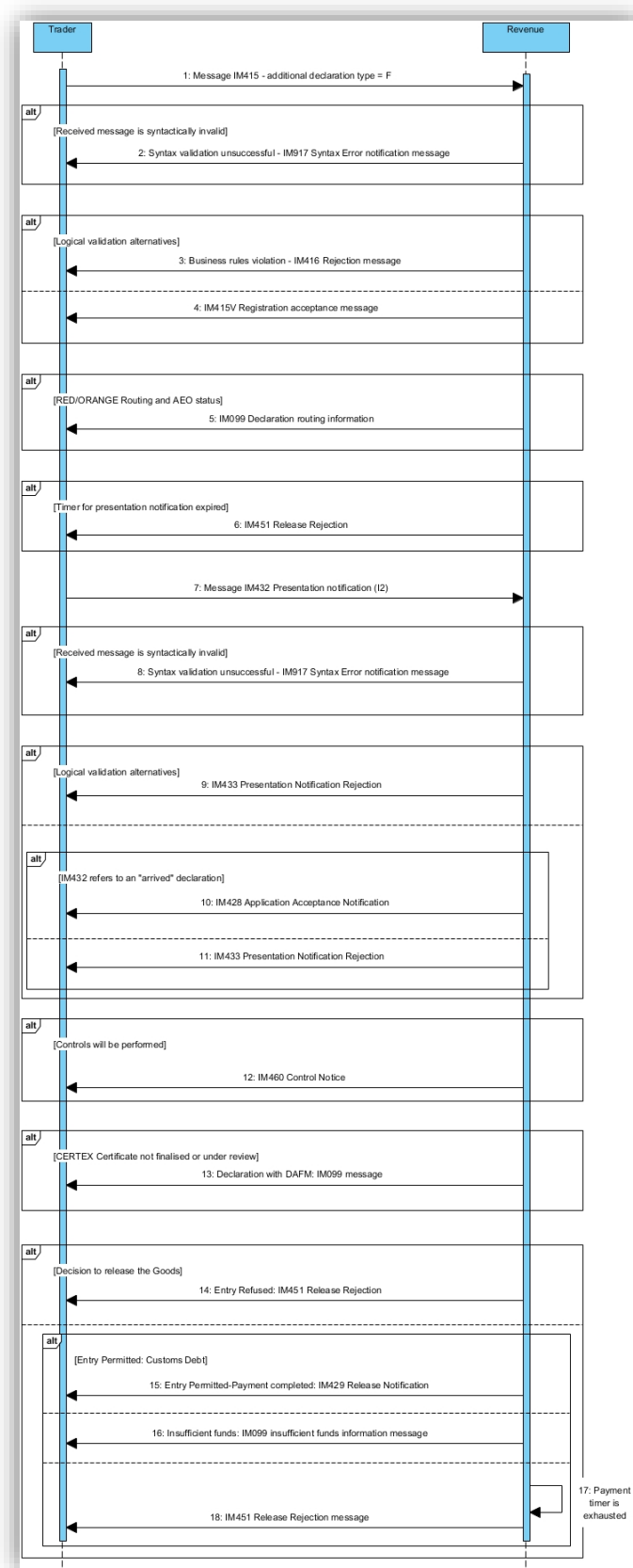

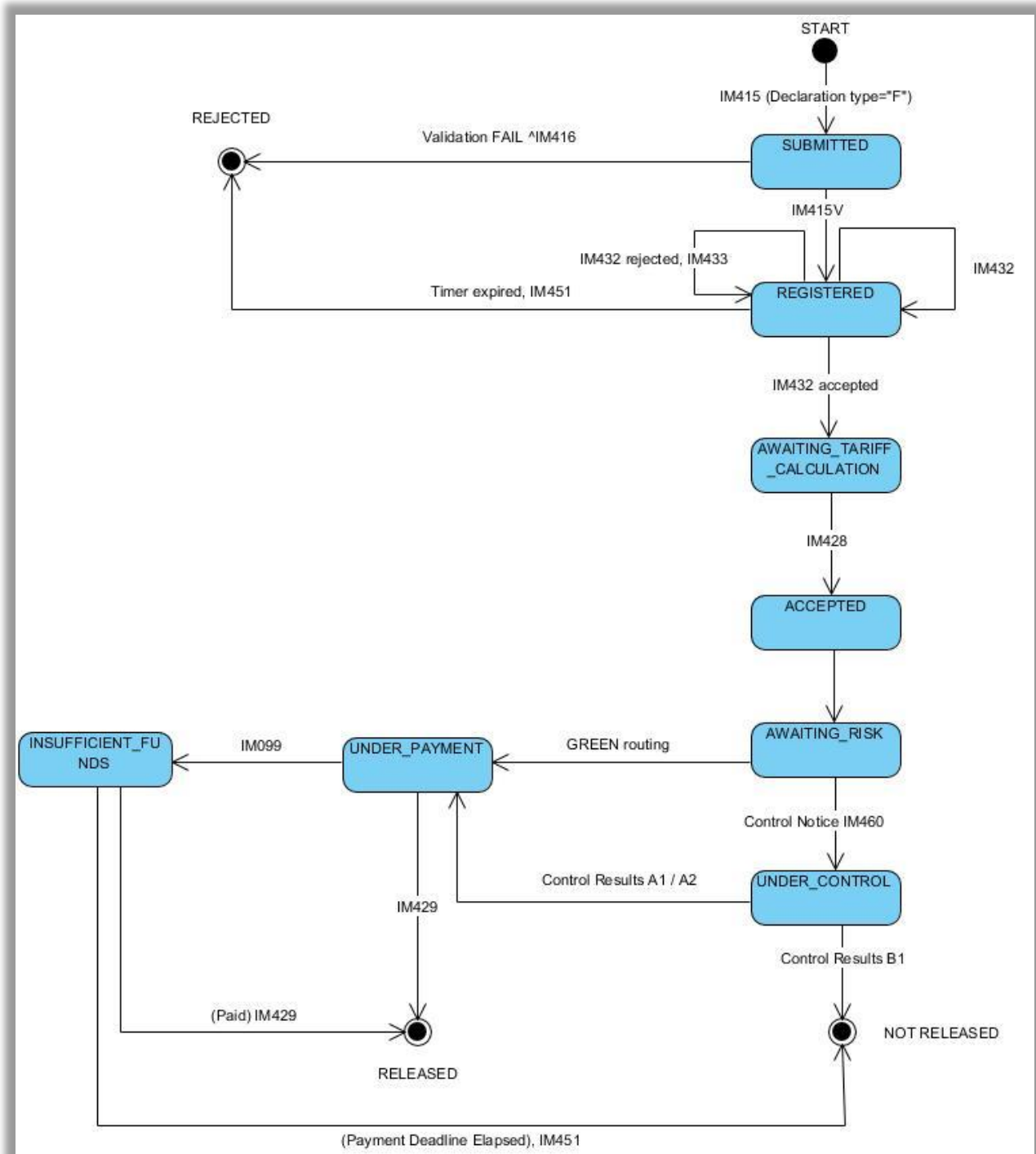

Core Flow (Happy Path) - Pre-lodged Simplified Customs Declaration with Supplementary waiver

1. AIS receives an IM415 message (additional declaration type = F)
2. The IM415 message is syntactically valid
3. The IM415 message is logically valid (No business rules violation)

4. AIS forwards an IM415V Customs Declaration Acknowledgment message to the Trader
5. The declaration is Green routed
6. AIS receives the IM432 message
7. The IM432 message is syntactically valid
8. The IM432 message is logically valid (No business rules violation)
9. The IM432 message refers to an “arrived” declaration
10. AIS forwards an IM428 acceptance message to the Trader

Alt 1 - The declaration is syntactically invalid

1. The process follows the Core Flow up to step 1
2. The IM415 message is syntactically invalid
3. AIS forwards an IM917 Syntax Error Notification message to the Trader

Alt 2 - The declaration is logically invalid

1. The process follows the Core Flow up to step 2
2. The message is logically invalid (Business rules violation)
3. AIS forwards an IM416 rejection message to the Trader

Alt 3 – RED/ORANGE Routing

1. The process follows the Core Flow up to step 4
2. The Declaration is Orange/Red routed
3. AIS forwards an IM099 advanced routing information to the declaration Importer if AEO

Alt 4 - Timer for presentation notification expired

1. The process follows the Core Flow up to step 5
2. The timer for Presentation Notification expires
3. AIS forwards an IM451 message to the Trader

Alt 5 - The presentation notification is syntactically invalid

1. The process follows the Core Flow up to step 6
2. The IM432 message is syntactically invalid
3. AIS forwards an IM917 Syntax Error Notification message to the Trader

Alt 6 – Logically invalid presentation notification

1. The process follows the Core Flow up to step 7
2. The IM432 is logically invalid (Business rules violation)
3. AIS forwards an IM433 rejection message to the Trader

Alt 7 – IM432 refers to a “non-arrived” declaration

1. The process follows the core flow up to step 8
2. The IM432 message refers to a “non-arrived” declaration
3. AIS forwards an IM433 rejection message to the Trader

Alt 8 - Controls will be performed (Goods presented)

1. The process follows the Alt 3 up to step 3

2. AIS forwards an IM460 Control Notice message to the Trader

Alt 9 – CERTEX Certificate not finalised or under review

1. The process follows the core flow up to step 9
2. CERTEX reference is not finalised or under review
3. AIS sends IM099 “Declaration with DAFM” message

Alt 10 - Decision to release the Goods - Entry Refused (Controls)

1. The process follows the Alt 8 up to step 2
2. The Goods cannot be released
3. AIS forwards an IM451 release rejection message to the Trader

Alt 11 - Decision to release the Goods - Entry Permitted

1. The process follows the Core Flow up to step 10 or positive control results
2. The payment process is completed successfully
3. The Goods can be released
4. AIS forwards an IM429 release notification message to the Trader

Alt 12 - Insufficient funds

1. The process follows the Core Flow up to step 10
2. Customs debt is due, Trader’s Revenue account has insufficient funds
3. AIS forwards an IM099 “insufficient funds” information message

Alt 13 - Timer for payment expired

1. The process follows the Alt 12 up to step 3
2. Trader has failed to fulfil their financial obligation to Revenue within a specified time-limit
3. AIS forwards an IM451 Release Rejection message

5.2.7 Supplementary Declaration

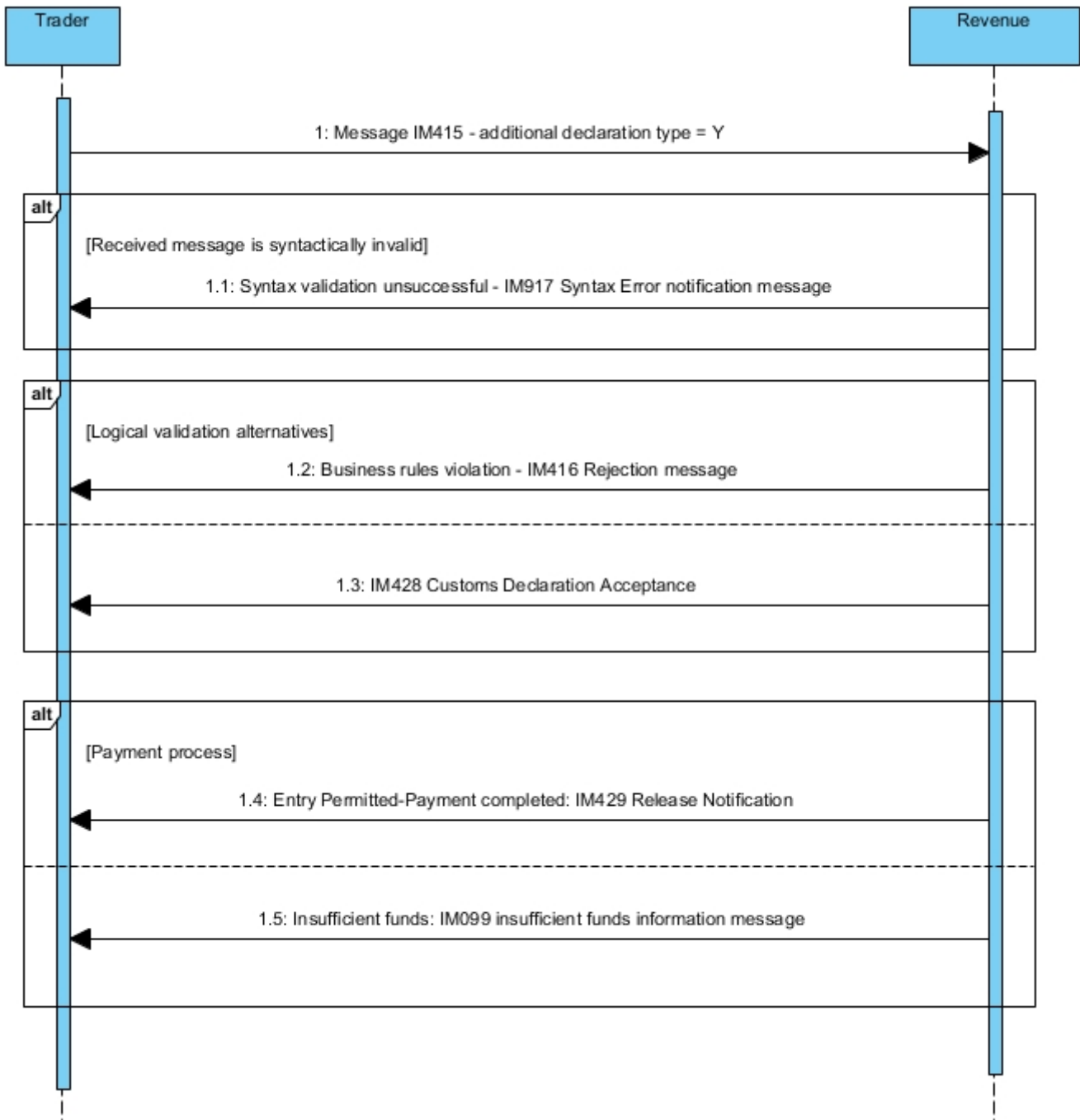

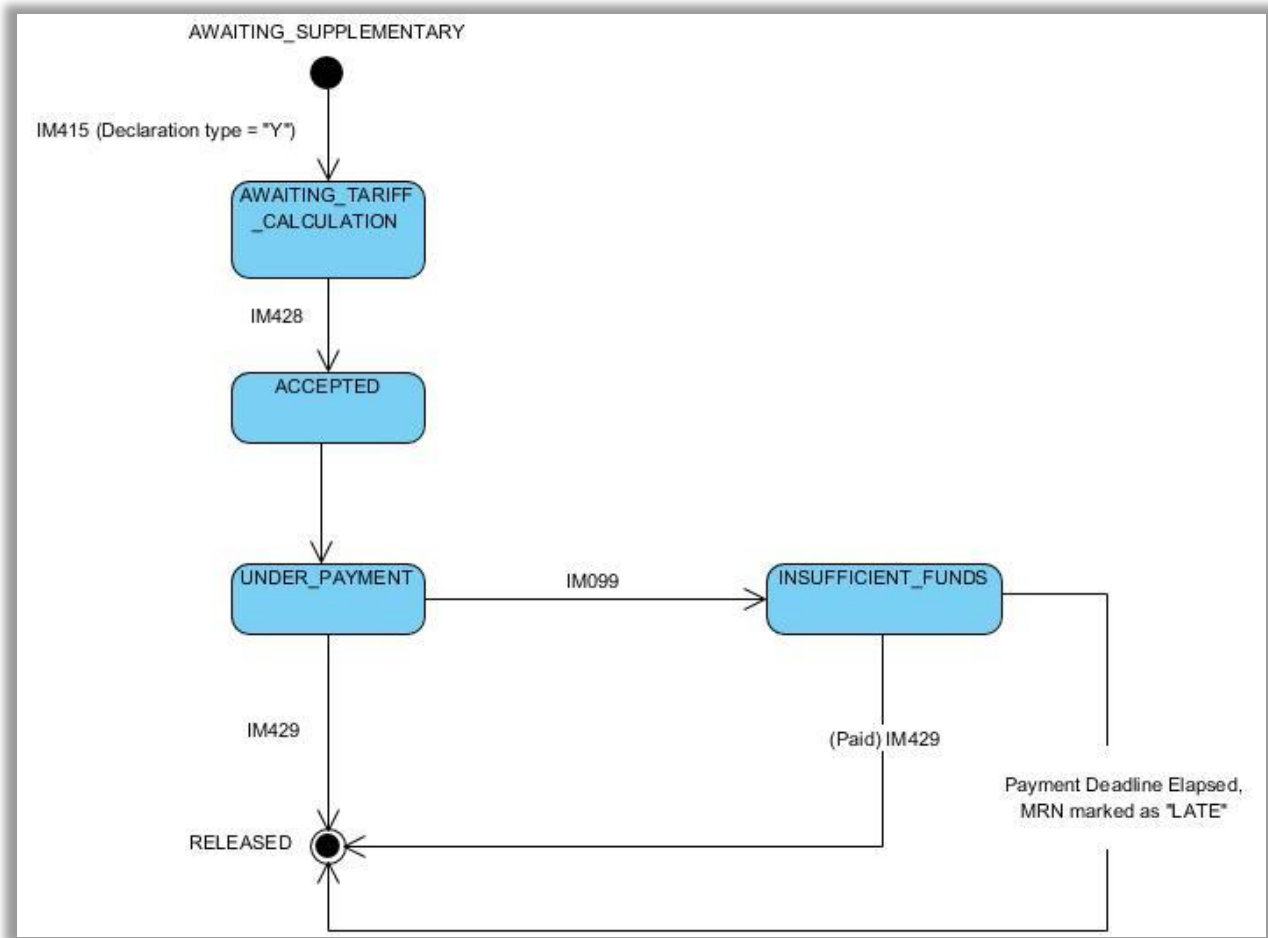

Preconditions

A simplified declaration (IM415) with additional declaration type C or F **WITHOUT** supplementary waiver (consignment level **DE 2/2 Code = N9000**)

Core Flow (Happy Path) - Supplementary Declaration

1. AIS receives an IM415 message - Additional declaration type = Y
2. The message is syntactically valid
3. The message is logically valid (No business rules violation)
4. AIS forwards an IM428 acceptance message to the Trader
5. Payment process completed successfully
6. AIS forwards an IM429 Release Notification message to the Trader

Alt 1 - The declaration is syntactically invalid

1. The process follows the Core Flow up to step 1
2. The IM415 message is syntactically invalid
3. AIS forwards an IM917 Syntax Error Notification message to the Trader

Alt 2 - The declaration is logically invalid

1. The process follows the Core Flow up to step 2

2. The message is logically invalid (Business rules violation)
3. AIS forwards an IM416 rejection message to the Trader

Alt 3 - Insufficient funds

1. The process follows the Core Flow up to step 4
2. Customs debt is due, Trader's Revenue account has insufficient funds
3. AIS sends an IM099 "Insufficient funds" information message to the Trader

5.2.8 EIDR with Presentation Notification and Supplementary Declaration (Type Z)

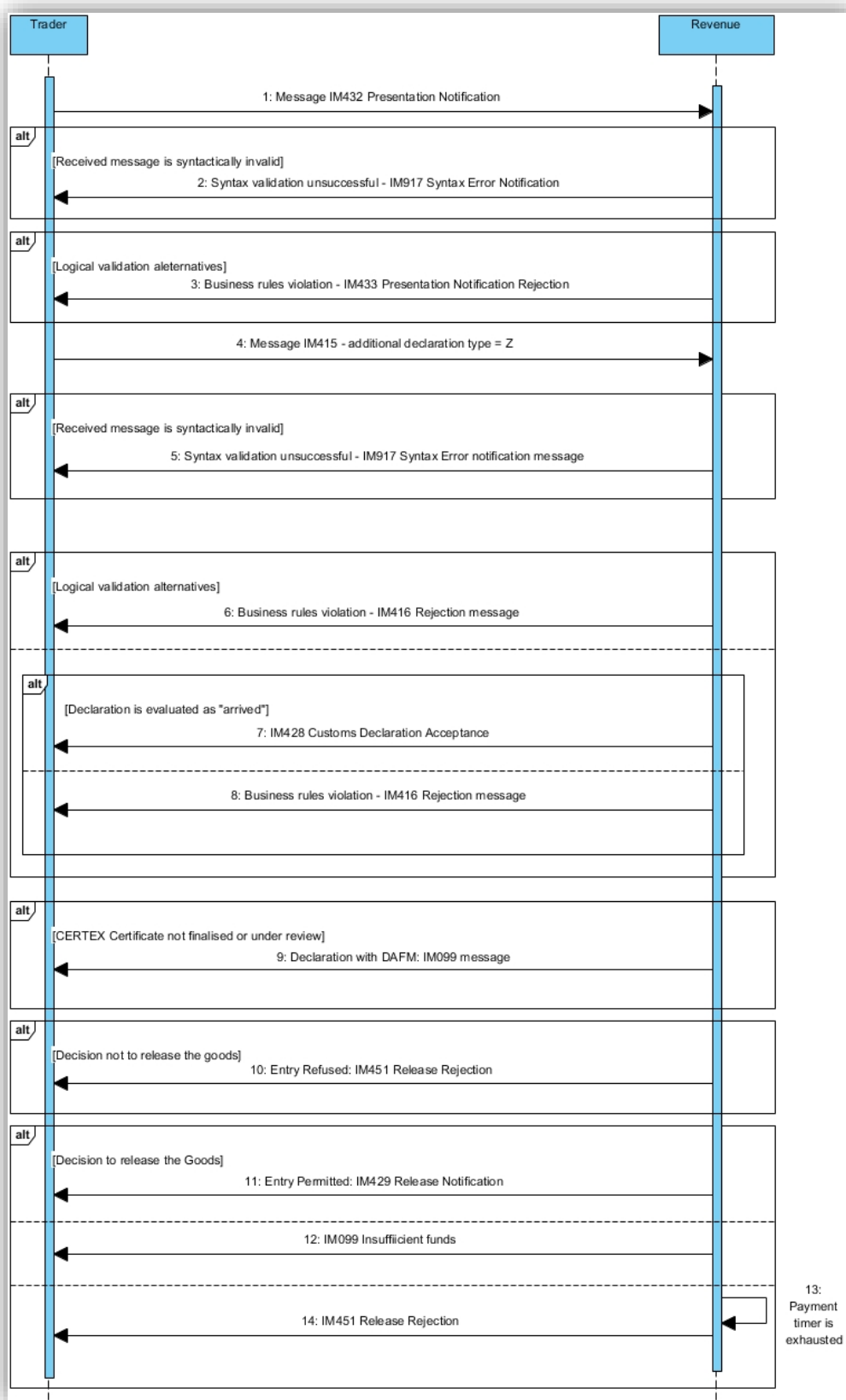

Core Flow (Happy Path) - EIDR with Presentation notification

1. AIS receives IM432 Presentation Notification
2. IM432 is syntactically valid
3. IM432 is logically valid
4. AIS receives an IM415 Supplementary Customs Declaration - Additional declaration type = Z message
5. The message is syntactically valid
6. The message is logically valid (No business rules violation)
7. The declaration is evaluated as “arrived”
8. AIS forwards an IM428 acceptance message to the Trader
9. The payment process is completed successfully
10. AIS sends an IM429 release message to the Trader

Alt 1 - IM432 is syntactically invalid

1. The process follows the core flow up to step 1
2. IM432 is syntactically invalid
3. AIS forwards an IM917 Syntax Error Notification message to the Trader

Alt 2 – IM432 is logically invalid

1. The process follows the core flow up to step 2
2. IM432 is logically invalid (Business rules violation)
3. AIS forwards an IM433 rejection message to the Trader

Alt 3 - The declaration is syntactically invalid

1. The process follows the core flow up to step 4
2. The message is syntactically invalid
3. AIS forwards an IM917 Syntax Error Notification message to the Trader

Alt 4 - The declaration is logically invalid

1. The process follows the core flow up to step 5
2. The message is logically invalid (Business rules violation)
3. AIS forwards an IM416 rejection message to the Trader

Alt 5 – The declaration is evaluated as “non-arrived”

1. The process follows the core flow up to step 6
2. The declaration is evaluated as “non-arrived”
3. AIS sends an IM416 rejection message to the Trader

Alt 6 – CERTEX Certificate not finalised or under review

1. The process follows the core flow up to step 7
2. CERTEX Certificate is not finalised or under review
3. AIS forwards IM099 “Declaration with DAFM” message to the Trader

Alt 7 - The Supplementary declaration is in 'Insufficient funds'

1. The process follows the core flow up to step 7
2. AIS forwards an IM099 "Insufficient funds" information message to the Trader

Alt 8 – Payment timer is exhausted

1. The process follows the Alt 5 up to step 2
2. Payment timer is exhausted
3. AIS forwards IM451 Release rejection message to the Trader

5.2.9 EIDR with Presentation notification waiver and Supplementary Declaration (Type Z)

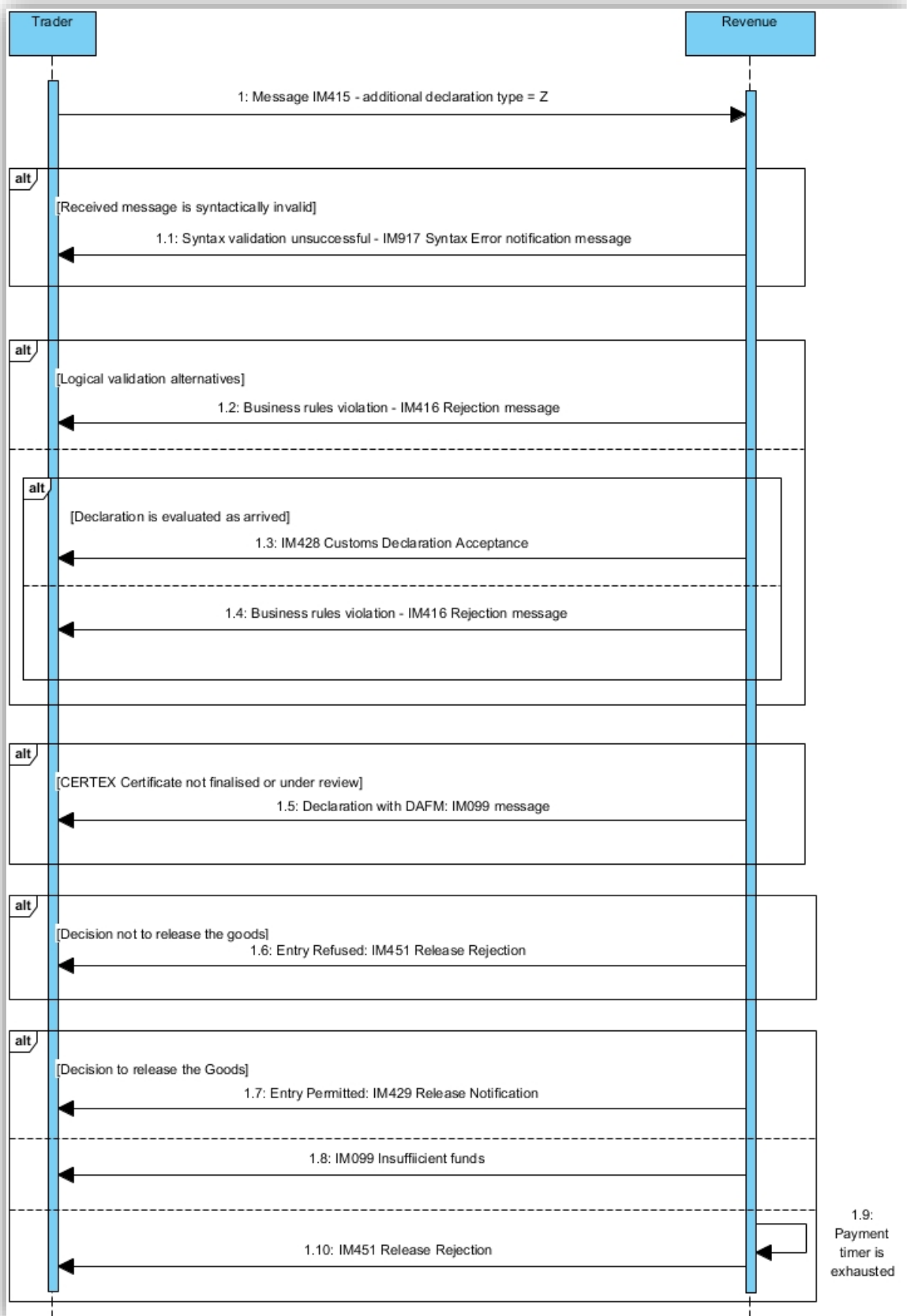

Core Flow (Happy Path) - EIDR - Presentation notification waiver

1. AIS receives an IM415 Supplementary Customs Declaration - Additional declaration type = Z message
2. The message is syntactically valid
3. The message is logically valid (No business rules violation)
4. The declaration is evaluated as “arrived”
5. AIS forwards an IM428 acceptance message to the Trader
6. The payment process is completed successfully
7. AIS sends an IM429 release message to the Trader

Alt 1 - The declaration is syntactically invalid

1. The process follows the core flow up to step 1
2. The message is syntactically invalid
3. AIS forwards an IM917 Syntax Error Notification message to the Trader

Alt 2 - The declaration is logically invalid

1. The process follows the core flow up to step 2
2. The message is logically invalid (Business rules violation)
3. AIS forwards an IM416 rejection message to the Trader

Alt 3 – The declaration is evaluated as “non-arrived”

1. The process follows the core flow up to step 3
2. The declaration is evaluated as “non-arrived”
3. AIS sends an IM416 rejection message to the Trader

Alt 4 – CERTEX Certificate not finalised or under review

1. The process follows the core flow up to step 5
2. CERTEX Certificate is not finalised or under review
3. AIS forwards IM099 “Declaration with DAFM” message to the Trader

Alt 5 - The Supplementary declaration is in ‘Insufficient funds’

1. The process follows the core flow up to step 5
2. AIS forwards an IM099 “insufficient funds” information message to the Trader

Alt 6 – Payment timer is exhausted

1. The process follows the Alt 5 up to step 2
2. Payment timer is exhausted
3. AIS forwards IM451 Release rejection message to the Trader

5.2.10 Amendment of the Customs Declaration

Declaration Amendment in [INSUFFICIENT_FUNDS] status

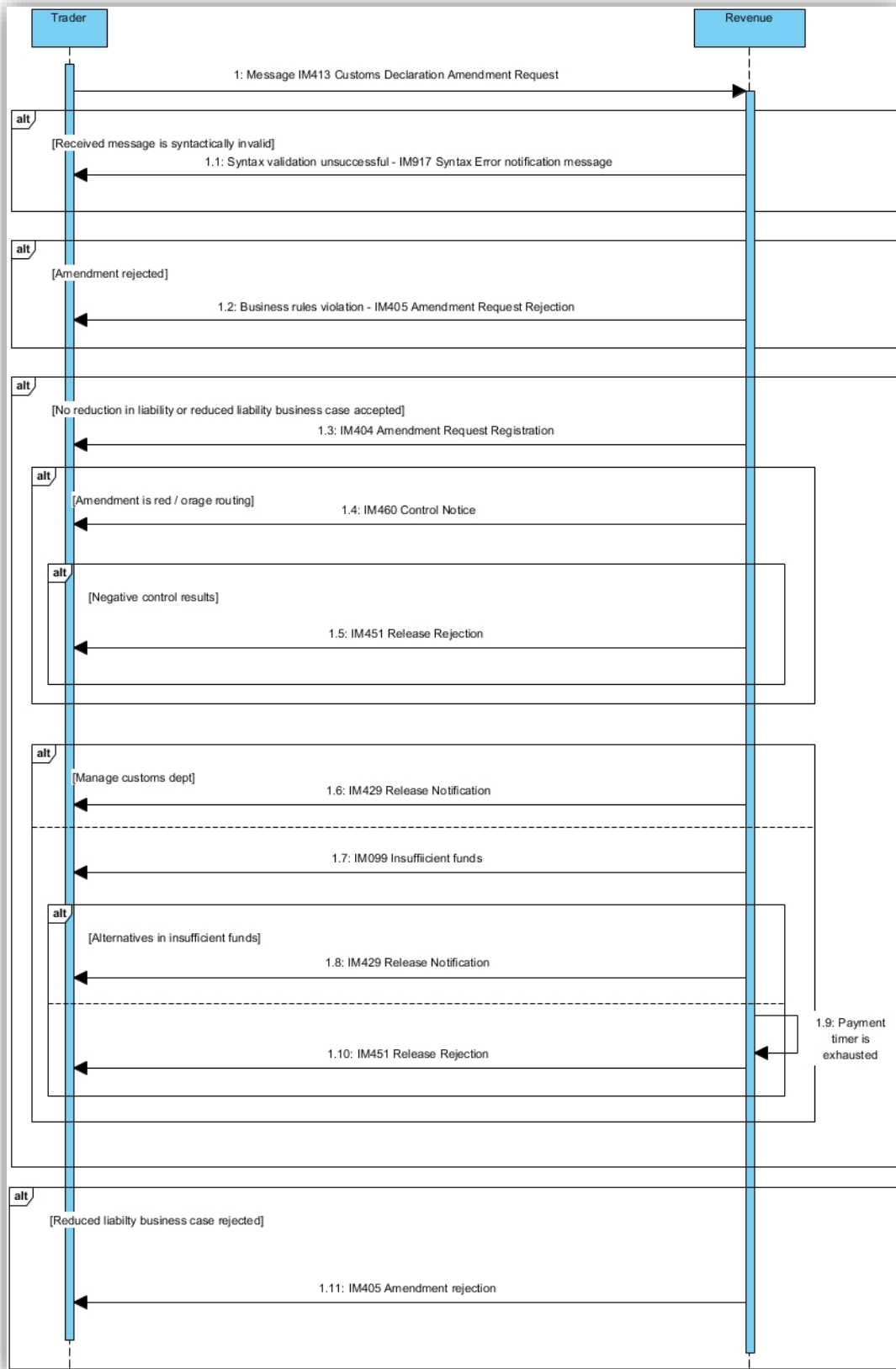

Declaration Amendment in [RELEASED] status

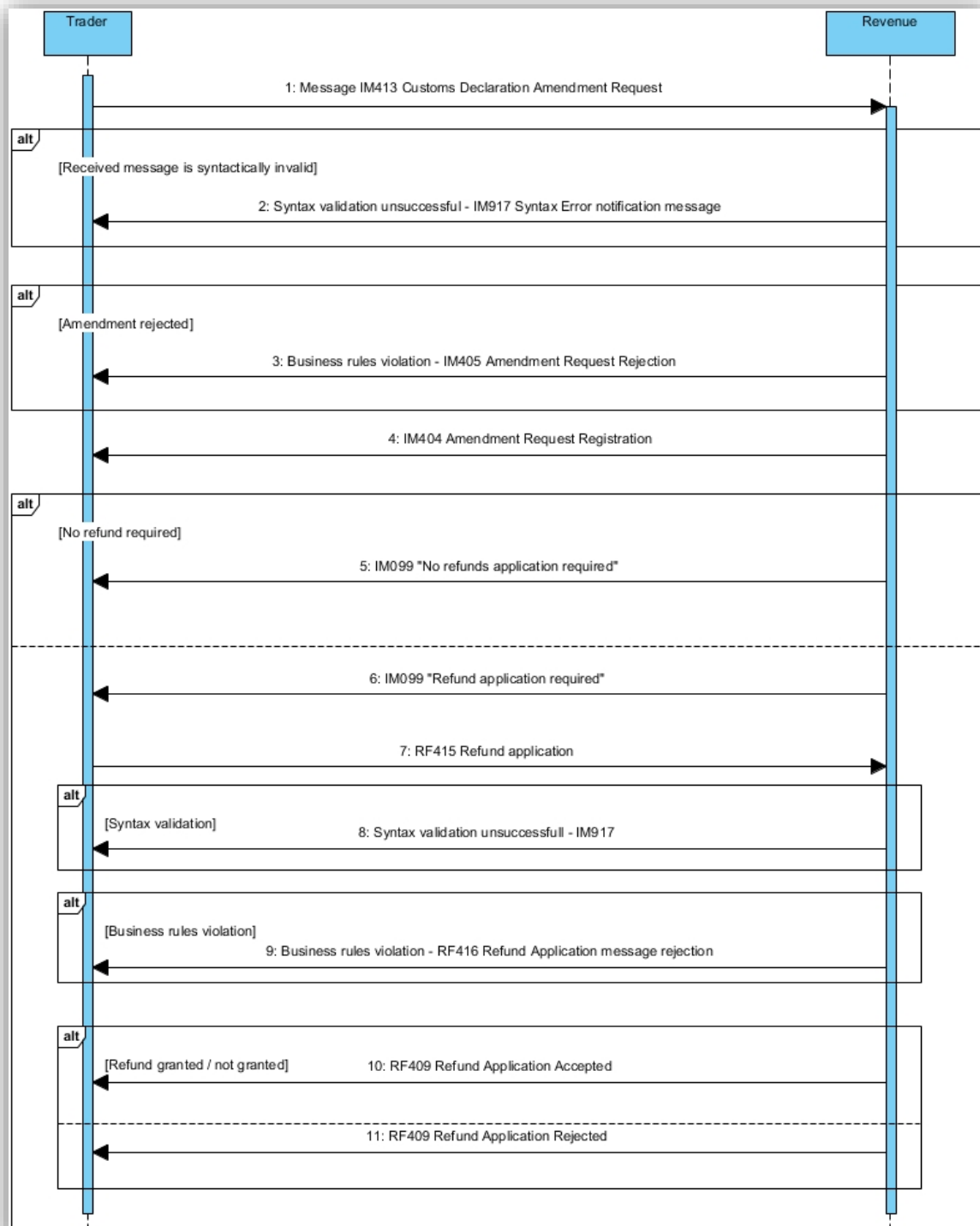

Declaration Amendment in [ACCEPTED] status

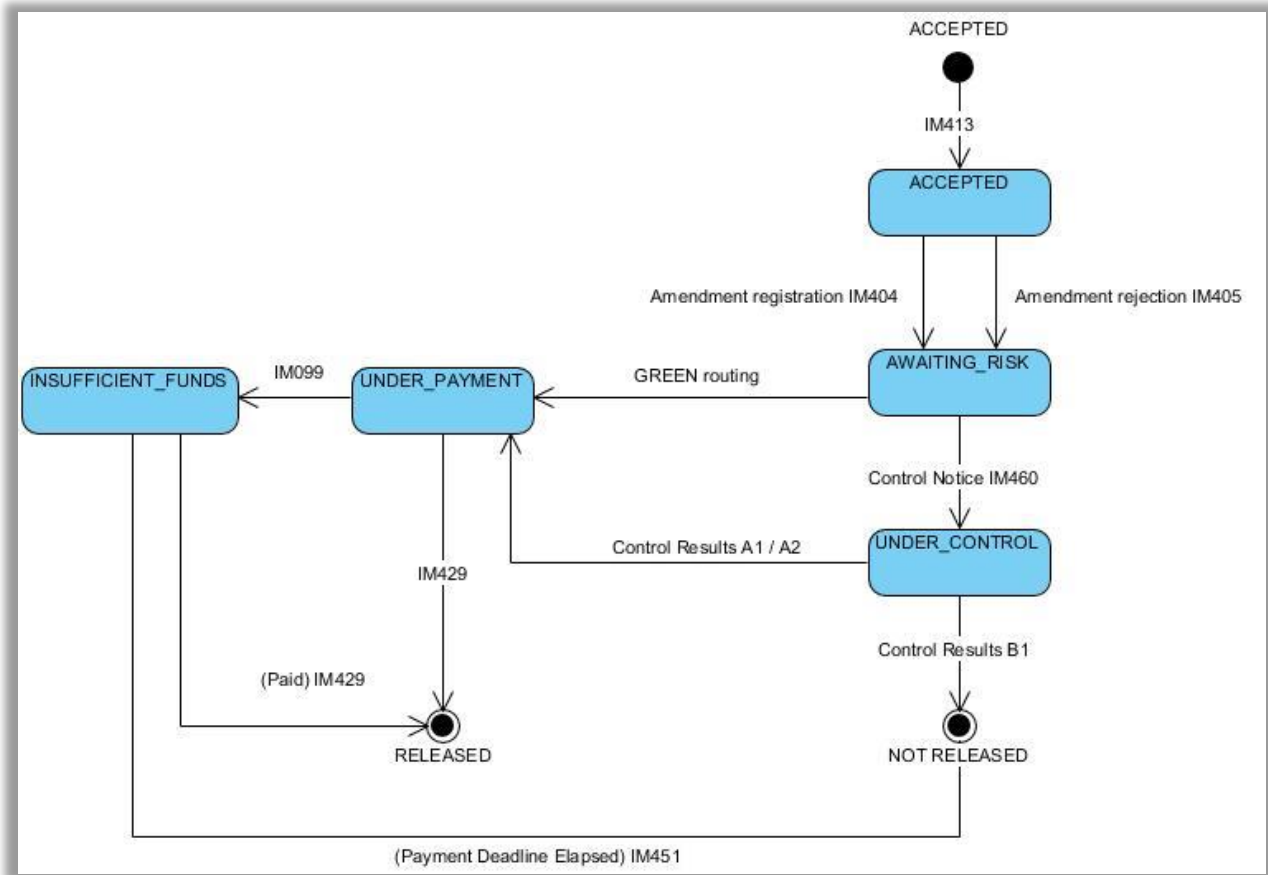

Declaration Amendment in [REGISTERED] status

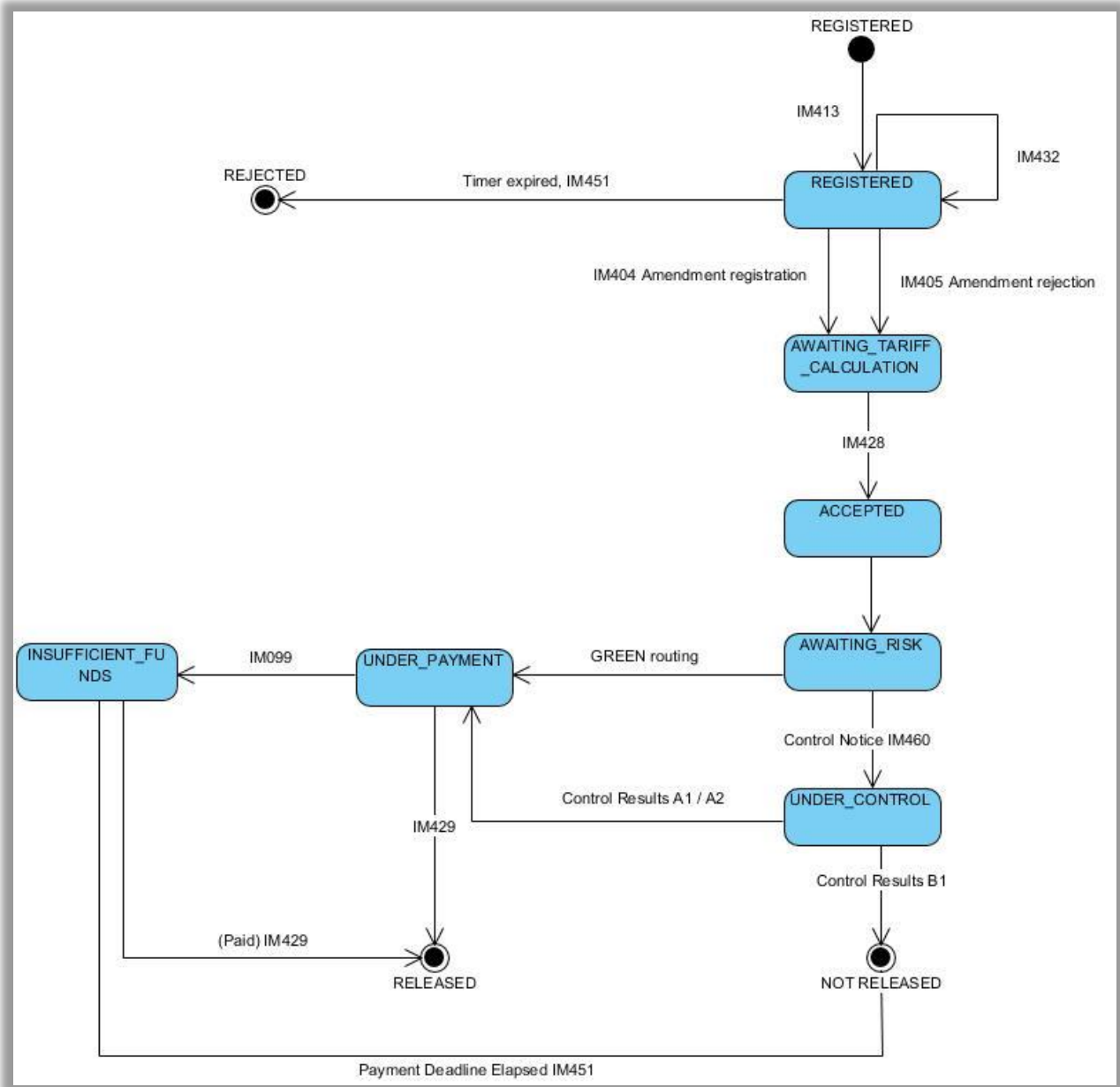

Declaration Amendment in [AWAITING_RISK] status

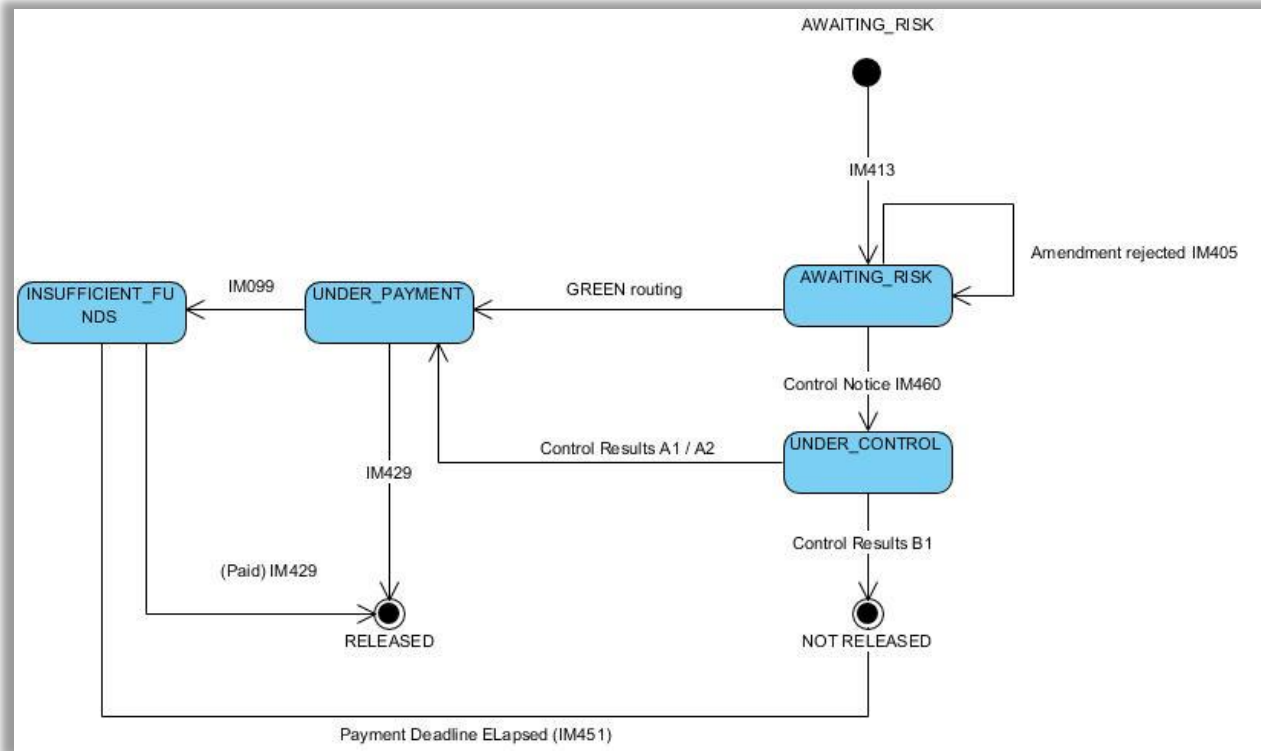

Declaration Amendment in [UNDER_PAYMENT] status

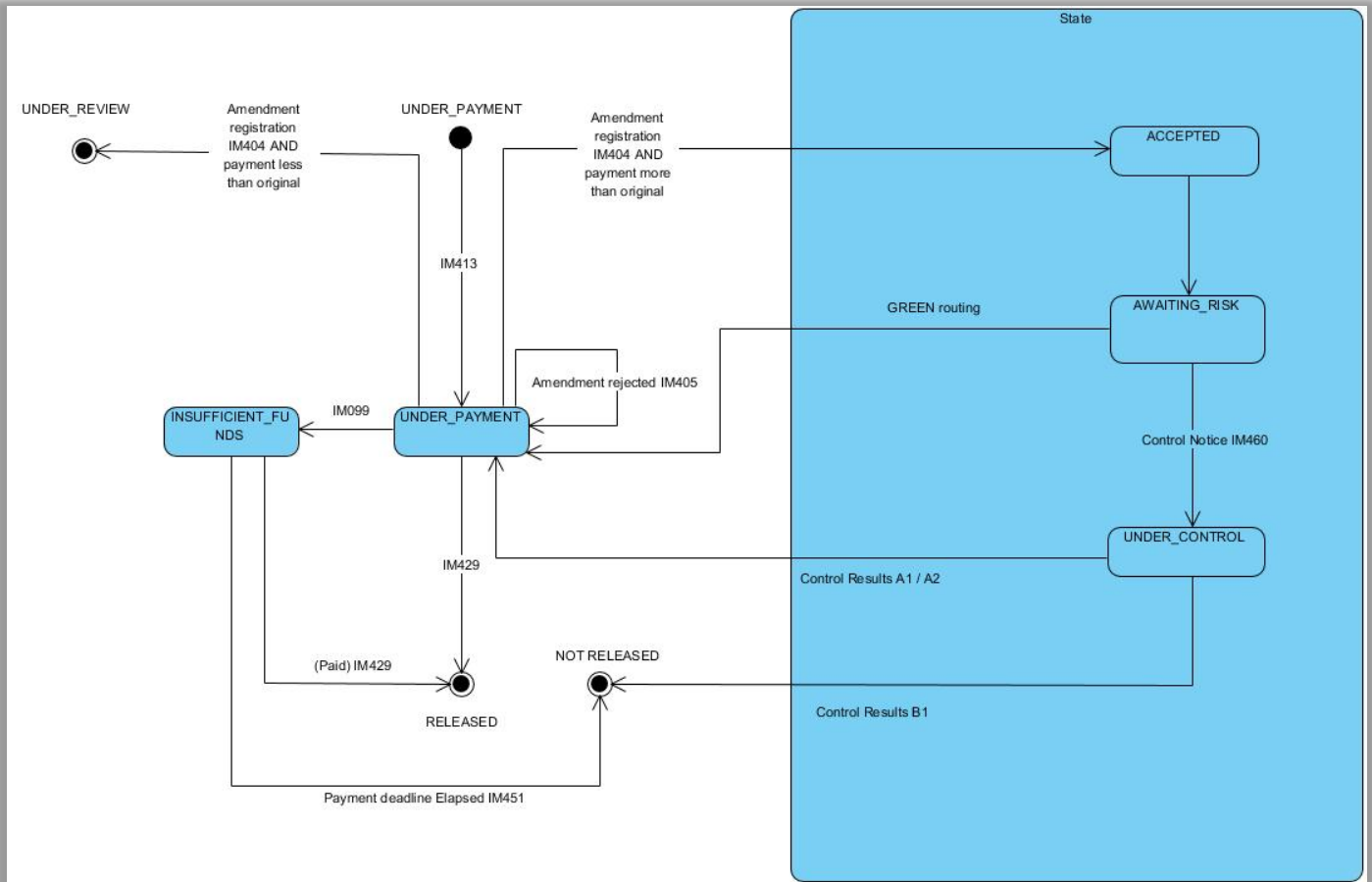

Declaration Amendment in [INSUFFICIENT_FUNDS] status

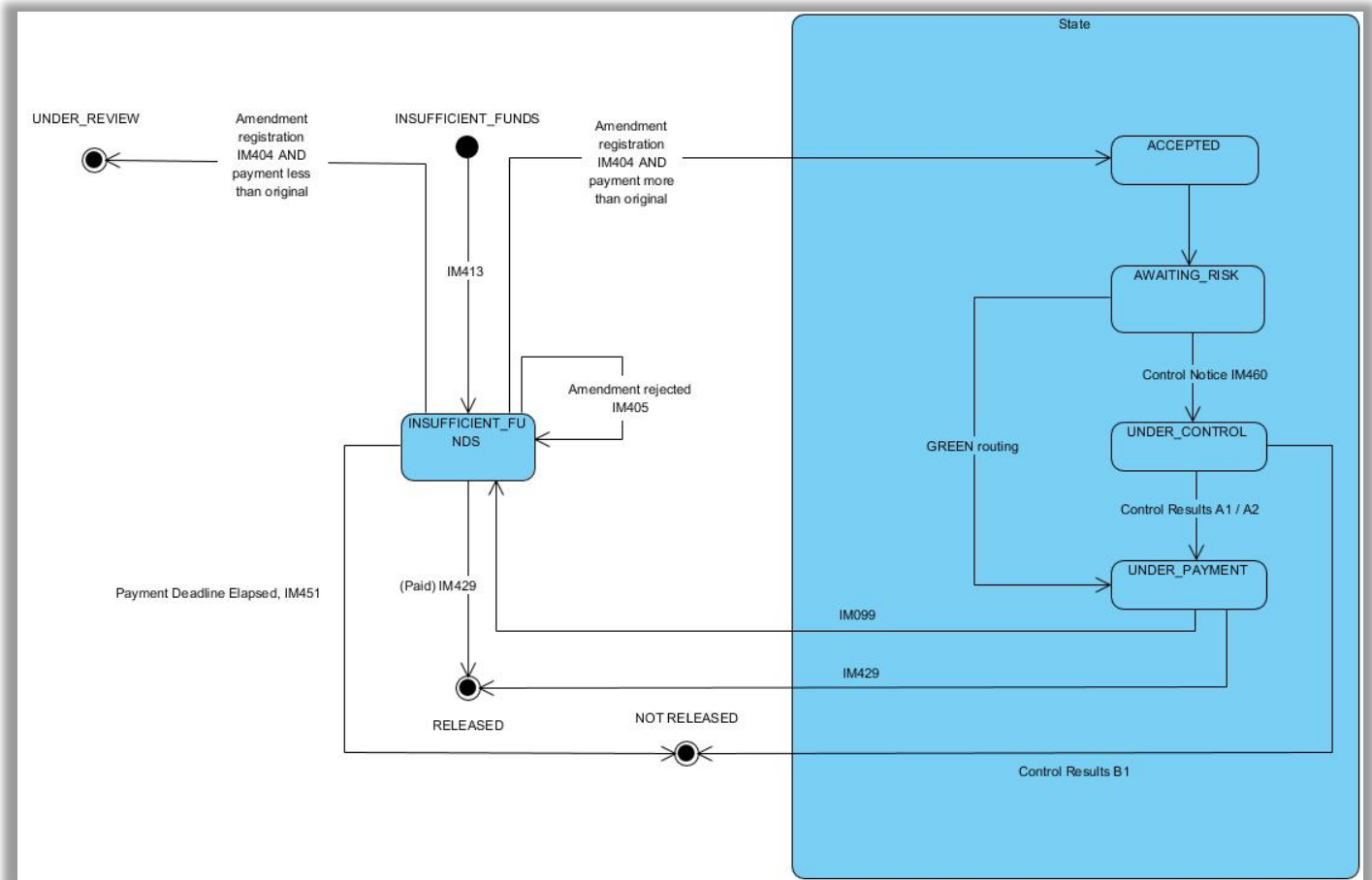

Declaration Amendment in [RELEASED] status

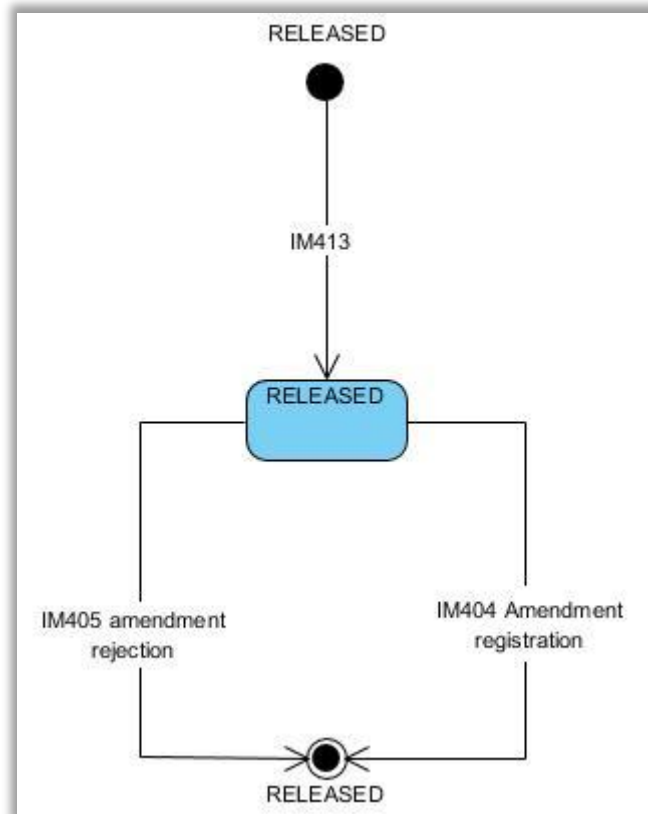

Core Flow (Happy Path) - Amendment of the Customs Declaration in [INSUFFICIENT_FUNDS] status

1. AIS receives an IM413 message
2. The message is syntactically valid
3. The message is logically valid (No business rules violation)
4. No reduction in liability or reduced liability business case accepted
5. AIS forwards an IM404 acceptance message to the Trader
6. The declaration is Green routed
7. The payment process is completed successfully
8. The Goods can be released
9. AIS forwards an IM429 release notification message to the Trader

Alt 1 - The request is syntactically invalid

1. Process follows the Core Flow up to step 1
2. The IM413 message is syntactically invalid
3. AIS forwards an IM917 Syntax Error Notification message to the Trader

Alt 2 - The request is logically invalid

1. Process follows the Core Flow up to step 2
2. The IM413 message is logically invalid (Business rules violation)
3. AIS forwards an IM405 Amendment Request Rejection message to the Trader

Alt 3 – Insufficient funds

1. Process follows the Core Flow up to step 6
2. No funds available
3. AIS forwards IM099 insufficient funds to the Trader

Alt 4 – Payment timer expired

1. Process follows the Alt 3 up to step 3
2. Payment timer is exhausted
3. AIS sends IM451 release rejection message to the Trader

Alt 5 – RED/ORANGE Routing and positive results

1. Process follows the Core Flow up to step 5
2. The Declaration is Orange/Red routed
3. AIS forwards an IM460 Control Notice message to the Trader
4. The payment process is completed successfully
5. The Goods can be released
6. AIS forwards an IM429 release notification message to the Trader

Alt 6 - RED/ORANGE Routing and positive results (insufficient funds)

1. Process follows the Alt 5 up to step 4
2. No funds available
3. AIS forwards IM099 insufficient funds to the Trader
4. If payment timer expires, process resumes from Alt 4 step 2

Alt 7 - RED/ORANGE Routing and negative results

1. Process follows the Alt 5 up to step 4
2. Control case is closed with negative results
3. AIS forwards an IM451 release rejection message to the Trader

Alt 8 – Reduced liability (Amendment request rejected after review)

1. The process follows the core flow up to step 3
2. AIS sends IM405 Amendment rejection message to the Trader

Declaration Amendment in [RELEASED] status

Core Flow (Happy Path) - Amendment of the Customs Declaration (Post release)

1. AIS receives an IM413 message
2. The message is syntactically valid
3. The message is logically valid (No business rules violation)
4. AIS forwards an IM404 acceptance message to the Trader
5. AIS forwards IM099 “No refund application required”

Alt 1 - The request is syntactically invalid

1. Process follows the Core Flow up to step 1
2. The IM413 message is syntactically invalid
3. AIS forwards an IM917 Syntax Error Notification message to the Trader

Alt 2 - The request is logically invalid

1. Process follows the Core Flow up to step 2
2. The IM413 message is logically invalid (Business rules violation)
3. AIS forwards an IM405 Amendment Request Rejection message to the Trader

Alt 3 – Refund application required and refund granted

1. Process follows the Core Flow up to step 4
2. AIS forwards IM099 “Refund application required”
3. AIS receives RF415 Refund application
4. RF415 is syntactically valid
5. RF415 is logically valid
6. AIS forwards RF409 Refund application accepted

Alt 4 – RF415 is syntactically invalid

1. Process follows the Alt 3 up to step 3
2. RF415 is syntactically invalid
3. AIS forwards Syntax validation unsuccessful - IM917

Alt 5 – RF415 is logically invalid

1. Process follows the Alt 3 up to step 4
2. RF415 is logically invalid
3. AIS forwards RF416 Refund Application message rejection to the Trader

Alt 6 - Refund application required and refund not granted

1. Process follows the Alt 3 up to step 5
2. Refund is not granted
3. AIS forwards RF409 Refund Application Rejected

5.2.11 Invalidation of the Customs Declaration

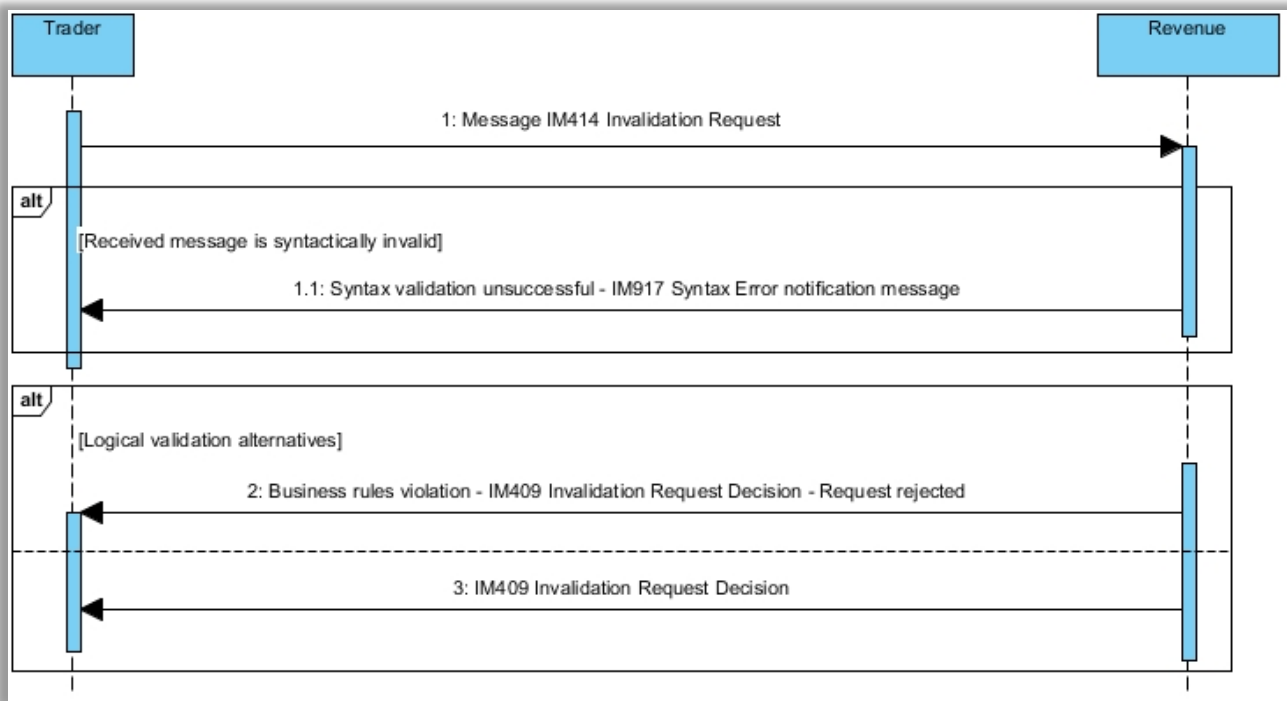

Declaration Invalidation Post release

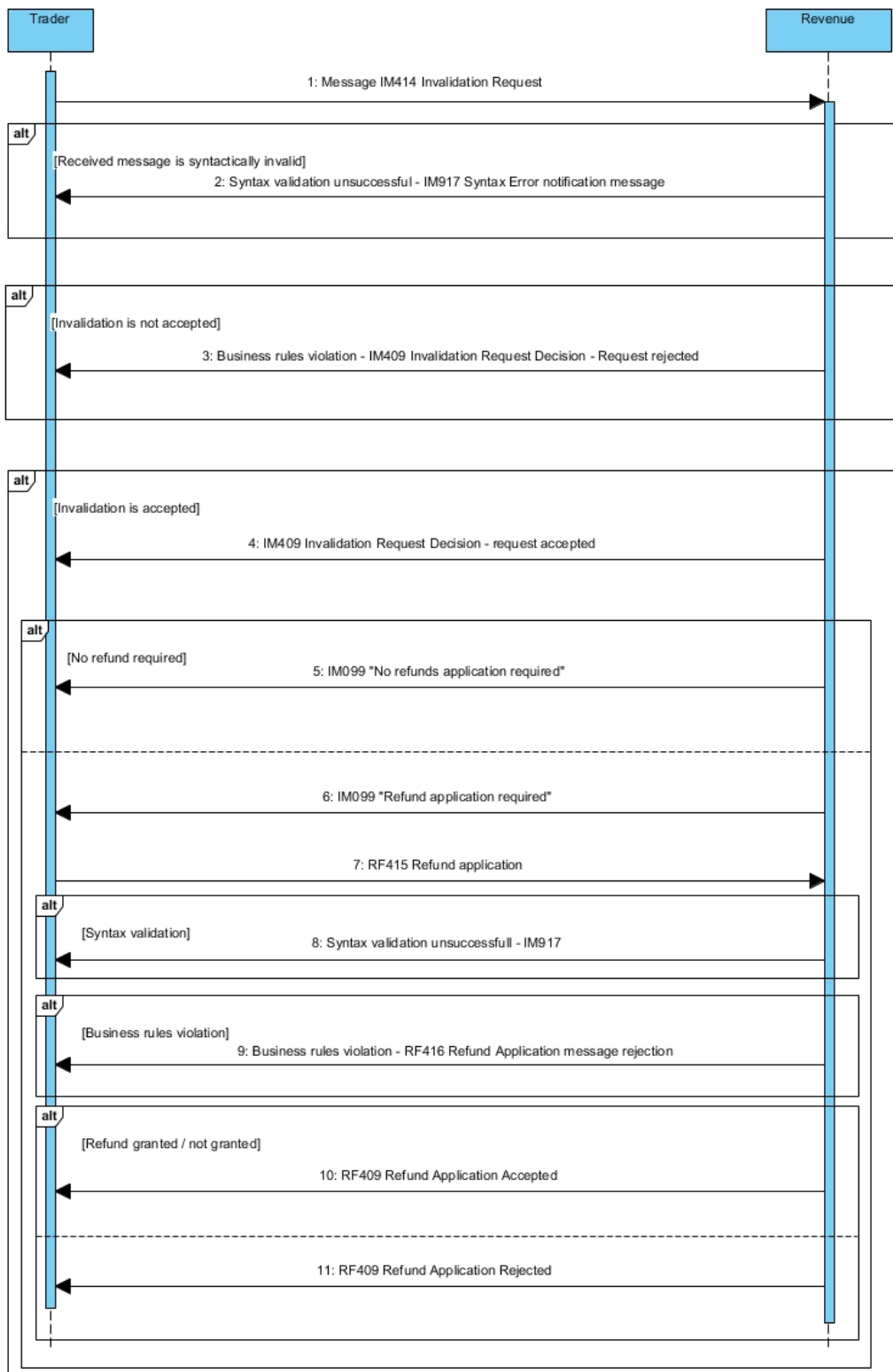

Declaration Invalidation in [ACCEPTED] status

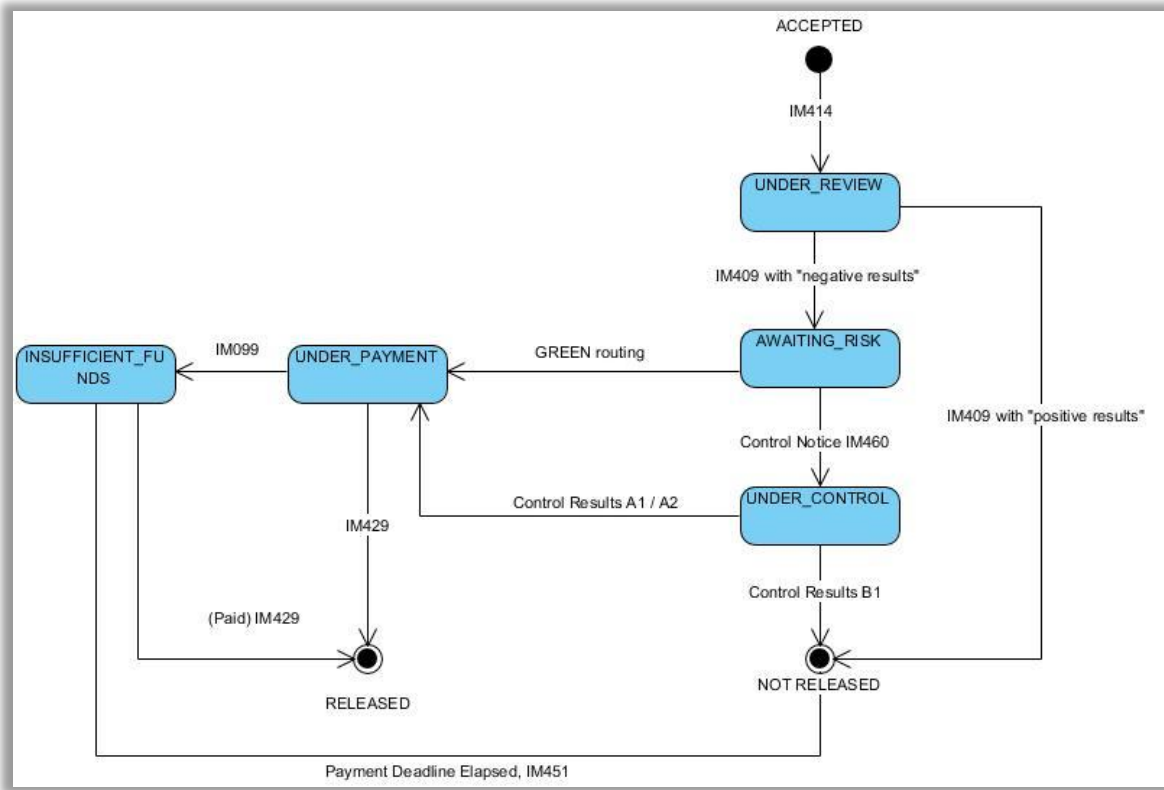

Declaration Invalidation in [REGISTERED] status

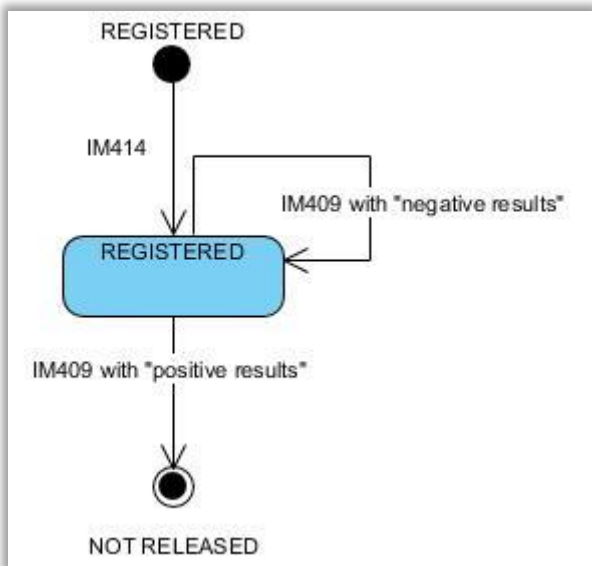

Declaration Invalidation in [UNDER_PAYMENT] status

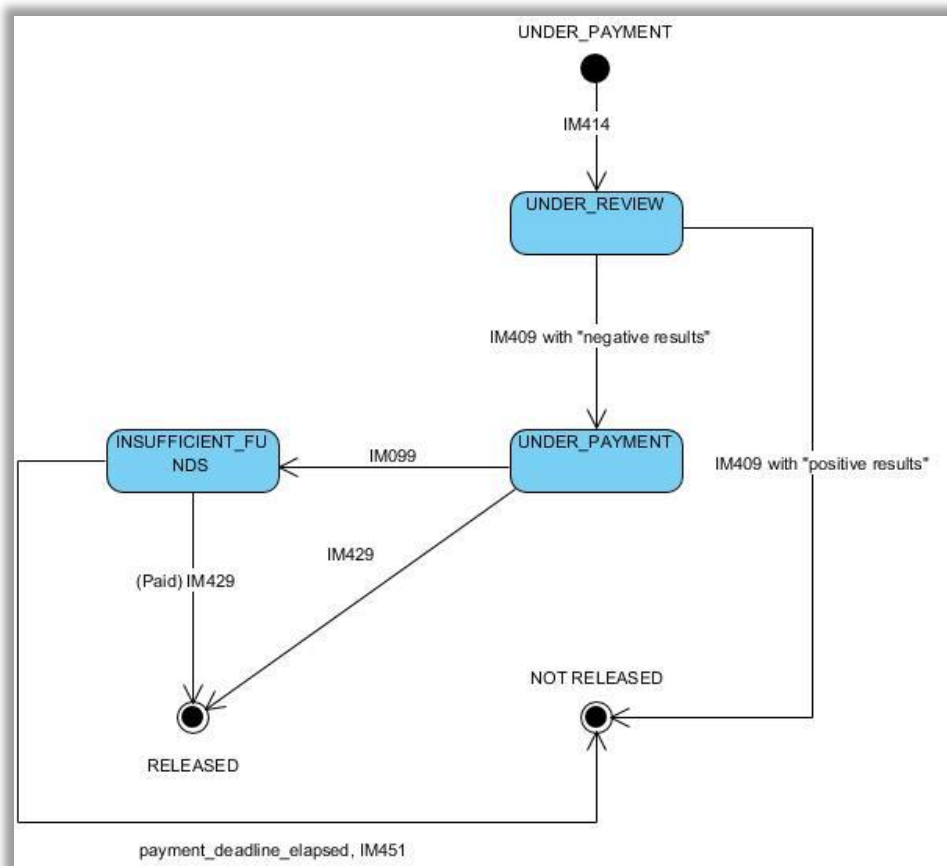

Declaration Invalidation in [INSUFFICIENT_FUNDS] status

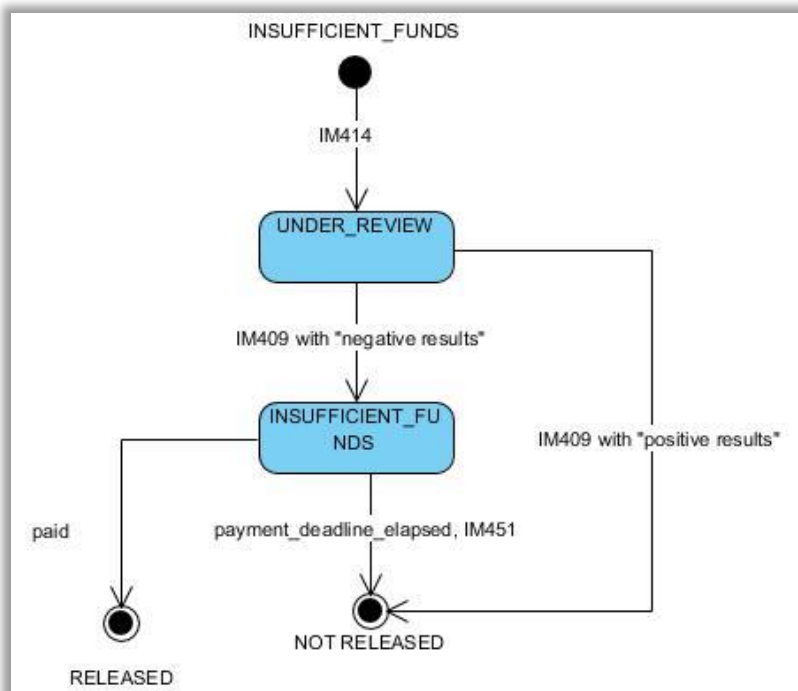

Declaration Invalidation in [RELEASED] status

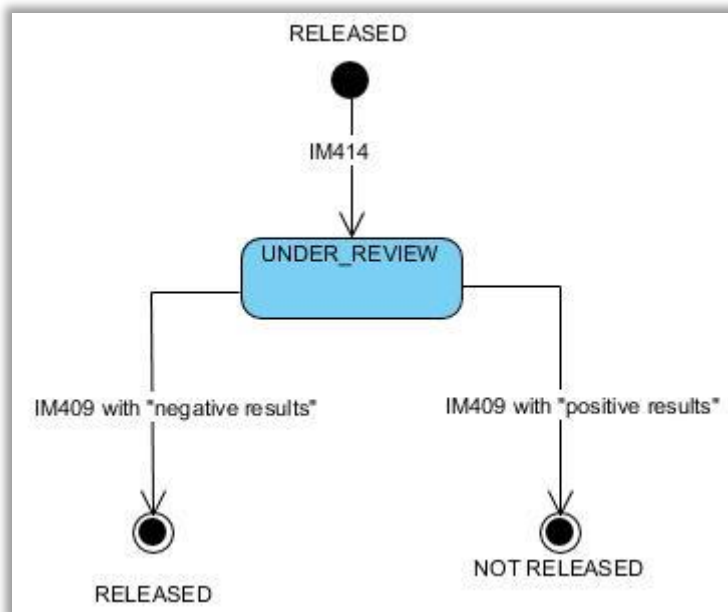

Core Flow – Invalidation of the Customs Declaration

1. AIS receives an IM414 message
2. The message is syntactically valid
3. The message is logically valid (No business rules violation)
4. The invalidation is accepted
5. AIS forwards an IM409 Invalidation Request Decision - request acceptance message to the Trader

Alt 1 - The request is syntactically invalid

1. Process follows the Core Flow up to step 1
2. The IM414 message is syntactically invalid
3. AIS forwards an IM917 Syntax Error Notification message to the Trader

Alt 2 - The request is logically invalid

1. Process follows the Core Flow up to step 2
2. The IM414 message is logically invalid (Business rules violation)
3. The invalidation is rejected
4. AIS forwards an IM409 Invalidation Request Decision - request rejected message to the Trader

Core Flow – Invalidation of the Customs Declaration (Post release)

1. AIS receives an IM414 message
2. The message is syntactically valid
3. The message is logically valid (No business rules violation)
4. The invalidation is accepted
5. AIS forwards an IM409 Invalidation Request Decision - request acceptance message to the Trader
6. No refund is required
7. AIS sends IM099 “No refund application required” to the Trader

Alt 1 - The request is syntactically invalid

1. Process follows the Core Flow up to step 1
2. The IM414 message is syntactically invalid
3. AIS forwards an IM917 Syntax Error Notification message to the Trader

Alt 2 - The request is logically invalid

1. Process follows the Core Flow up to step 2
2. The IM414 message is logically invalid (Business rules violation)
3. The invalidation is rejected
4. AIS forwards an IM409 Invalidation Request Decision - request rejected message to the Trader

Alt 3 – Refund required and granted

1. Process follows the core flow up to step 5
2. Refund is required
3. AIS sends IM099 “Refund application required” to the Trader
4. AIS receives RF415 Refund application
5. RF415 is syntactically valid
6. RF415 is logically valid – no business rules violation
7. AIS sends RF409 Refund application accepted

Alt 4 – The RF415 is syntactically invalid

1. Process follows the Alt 3 up to step 4
2. RF415 is syntactically invalid
3. AIS sends IM917 Syntax Error Notification message to the Trader

Alt 5 - The RF415 is logically invalid (Business rules violation)

1. Process follows the Alt 3 up to step 5
2. The RF415 is logically invalid
3. The RF415 is rejected
4. AIS forwards RF416 Refund application message rejection

Alt 6 – Refund is required but not granted

1. Process follows the Alt 3 up to step 6
2. Refund is not granted
3. AIS sends RF409 Refund application rejected

6 Import - Special procedures

6.1 Messages

List of messages code and description that may be exchanged

ID	Description	Sent by
IM099	General Notification and Request Information message	AIS
IM917	Syntax Error notification message	AIS
Special Procedures		
IM409	Invalidation Request Decision	AIS
IM414	Invalidation Request	TRADER
IM415	Customs Declaration	TRADER
IM415V	Customs Declaration Acknowledgment	AIS
IM416	Customs Declaration Rejection	AIS
IM428	Customs Declaration Acceptance	AIS
IM429	Release Notification	AIS
IM432	Presentation Notification	TRADER
IM433	Presentation Notification Rejection	AIS
IM451	Release Rejection	AIS
IM460	Control Notice	AIS

6.2 Use Cases

6.2.1 Prior Import for Outward Processing

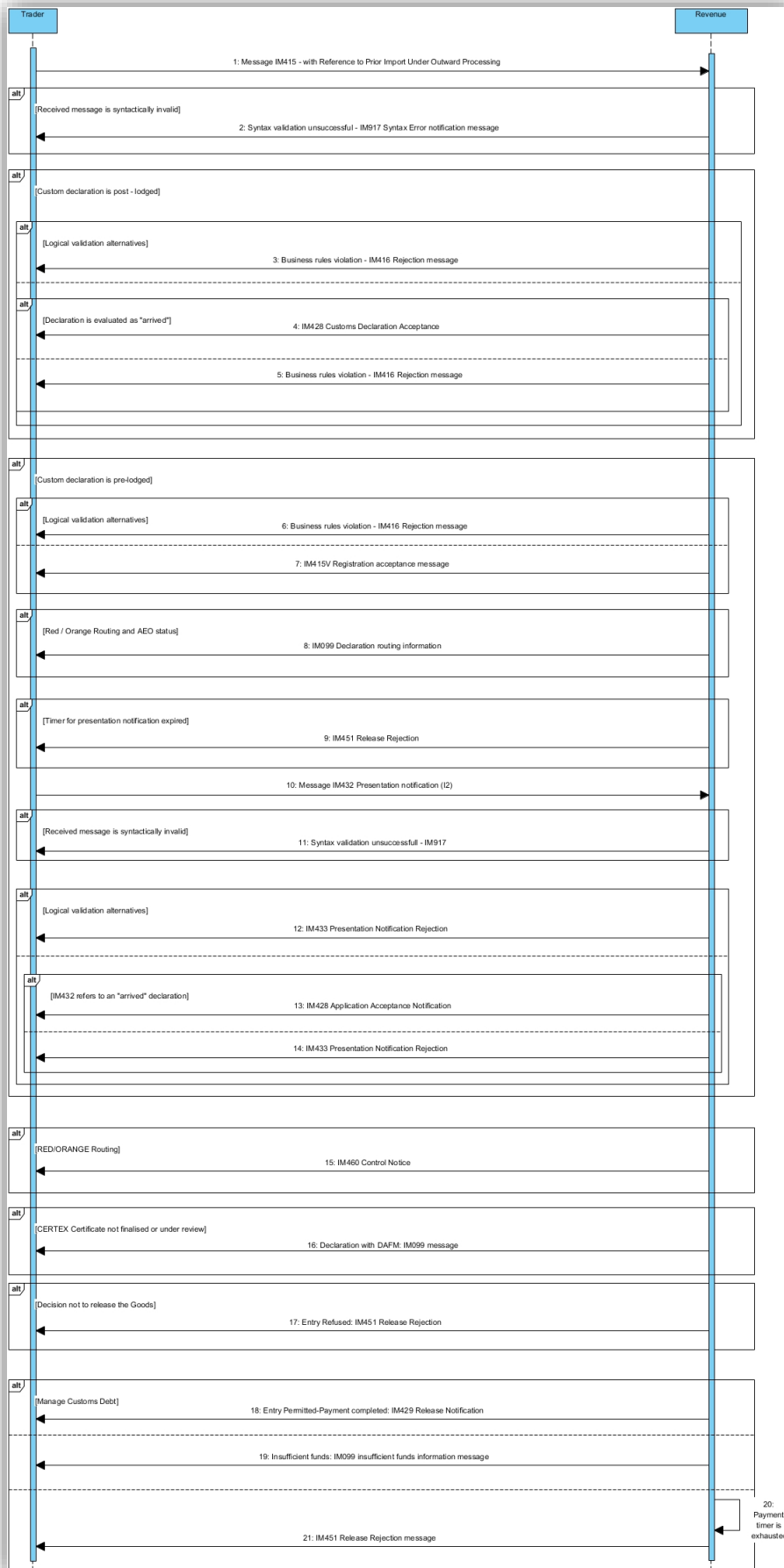

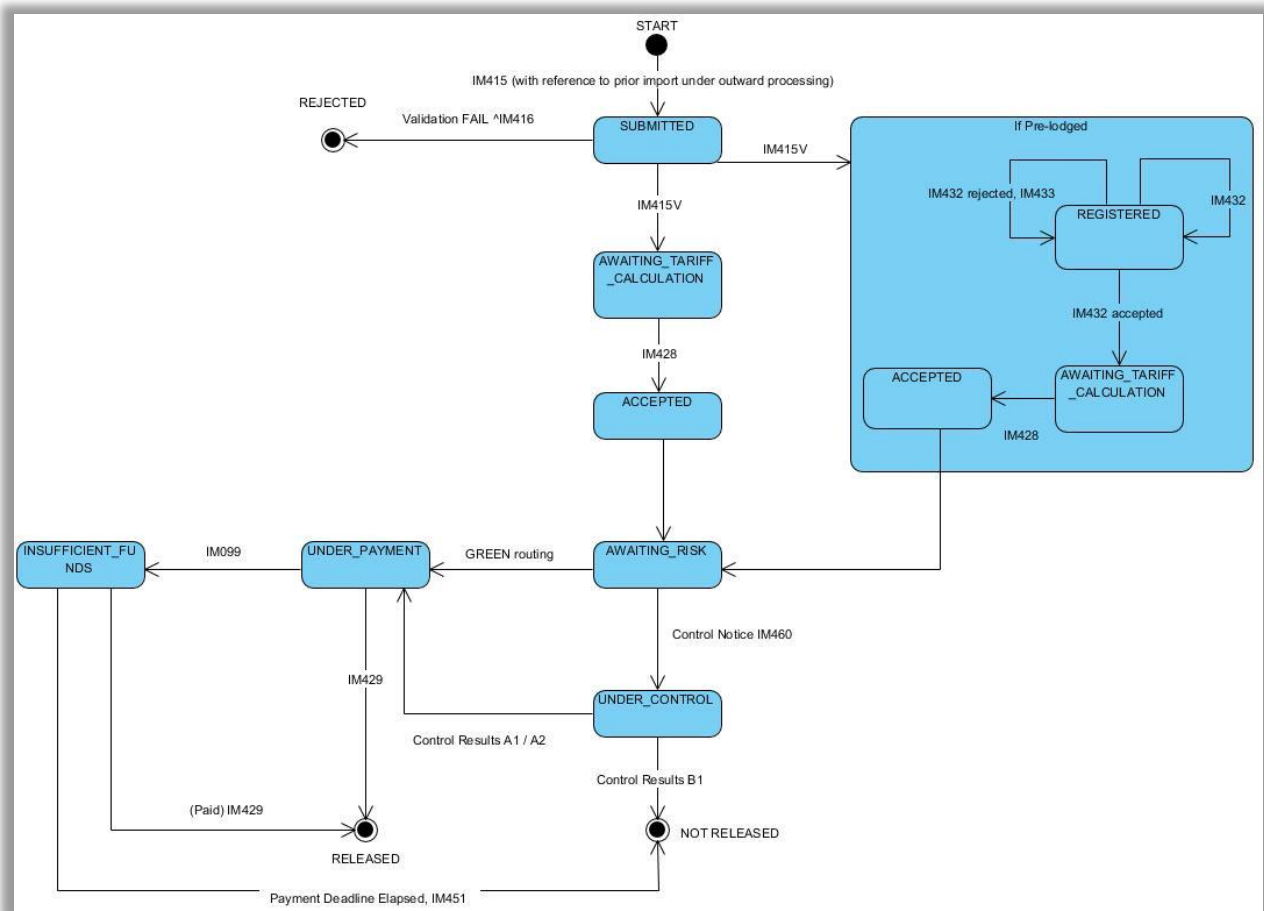

Core Flow (Happy Path) - Prior Import for Outward Processing

1. AIS receives an IM415 message - with Reference to Prior Import Under Outward Processing
2. The message is syntactically valid
3. The message is logically valid (No business rules violation)
4. Declaration is evaluated as "arrived"
5. AIS forwards an IM428 acceptance message to the Trader
6. The declaration is Green routed or positive control result (after Alt 9 step 3)
7. Payment process completed successfully
8. AIS forwards an IM429 Release Notification message to the Trader

Alt 1 - The declaration is syntactically invalid

1. The process follows the core flow up to step 1
2. The IM415 message is syntactically invalid
3. AIS forwards an IM917 Syntax Error Notification message to the Trader

Alt 2 - The declaration is logically invalid

1. The process follows the core flow up to step 2
2. The IM415 message is logically invalid (Business rules violation)
3. AIS forwards an IM416 rejection message to the Trader

Alt 3 - Customs declaration is pre-logged

1. The process follows the core flow up to step 3
2. AIS forwards an IM415V Customs Declaration Acknowledgment message to the Trader
3. AIS receive IM432 presentation notification
4. IM432 is syntactically valid
5. IM432 is logically valid
6. The IM432 message refers to an “arrived” declaration
7. Process continues from step 5 of the core flow

Alt 4 - Red / orange routing and AEO status

1. The process follows the Alt 3 up to step 2
2. Routing is red / orange and AEO status
3. IM099 with declaration routing information is sent to the Trader

Alt 5 – Timer for presentation notification is expired

1. The process follows the Alt 3 up to step 2
2. The timer for presentation notification is expired
3. IM451 Release rejection is sent to the Trader

Alt 6 - The presentation notification is syntactically invalid

1. The process follows the Alt 3 up to step 3
2. The IM432 message is syntactically invalid
3. AIS forwards an IM917 Syntax Error Notification message to the Trader

Alt 7 – The presentation notification is logically invalid

1. The process follows the Alt 3 up to step 4
2. The message is logically invalid (Business rules violation)
3. AIS forwards an IM433 rejection message to the Trader

Alt 8 - IM432 refers to a “non-arrived” declaration

1. The process follows the Alt 3 up to step 5
2. IM432 refers to a “non-arrived” declaration
3. AIS forwards an IM433 rejection message to the Trader

Alt 9 – RED/ORANGE Routing

1. The process follows the core flow up to step 5
2. The Declaration is Red/Orange routed
3. AIS forwards an IM460 Control Notice message to the Trader

Alt 10 – CERTEX Certificate not finalised or under review

1. The process follows the core flow up to step 6
2. CERTEX certificate is not finalised
3. AIS sends IM099 – “Declaration with DAFM” message to the Trader

Alt 11 - Decision to release the Goods - Entry Refused

1. The process follows the Alt 9 to step 3
2. The Goods cannot be released
3. AIS forwards an IM451 release rejection message to the Trader

Alt 11 - Insufficient funds

1. The process follows the core flow up to step 6
2. Customs debt is due, Trader's Revenue account has insufficient funds
3. AIS sends an IM099 "insufficient funds" information message to the Trader

Alt 12 - Timer for payment expired

1. The process follows the Alt 11 up to step 3
2. Trader has failed to fulfil their financial obligation to Revenue within a specified time-limit
3. AIS sends an IM451 Release Rejection message to the Trader

Note: This sequence also applies to declaration constitutes application (EUCDM 8f) cases

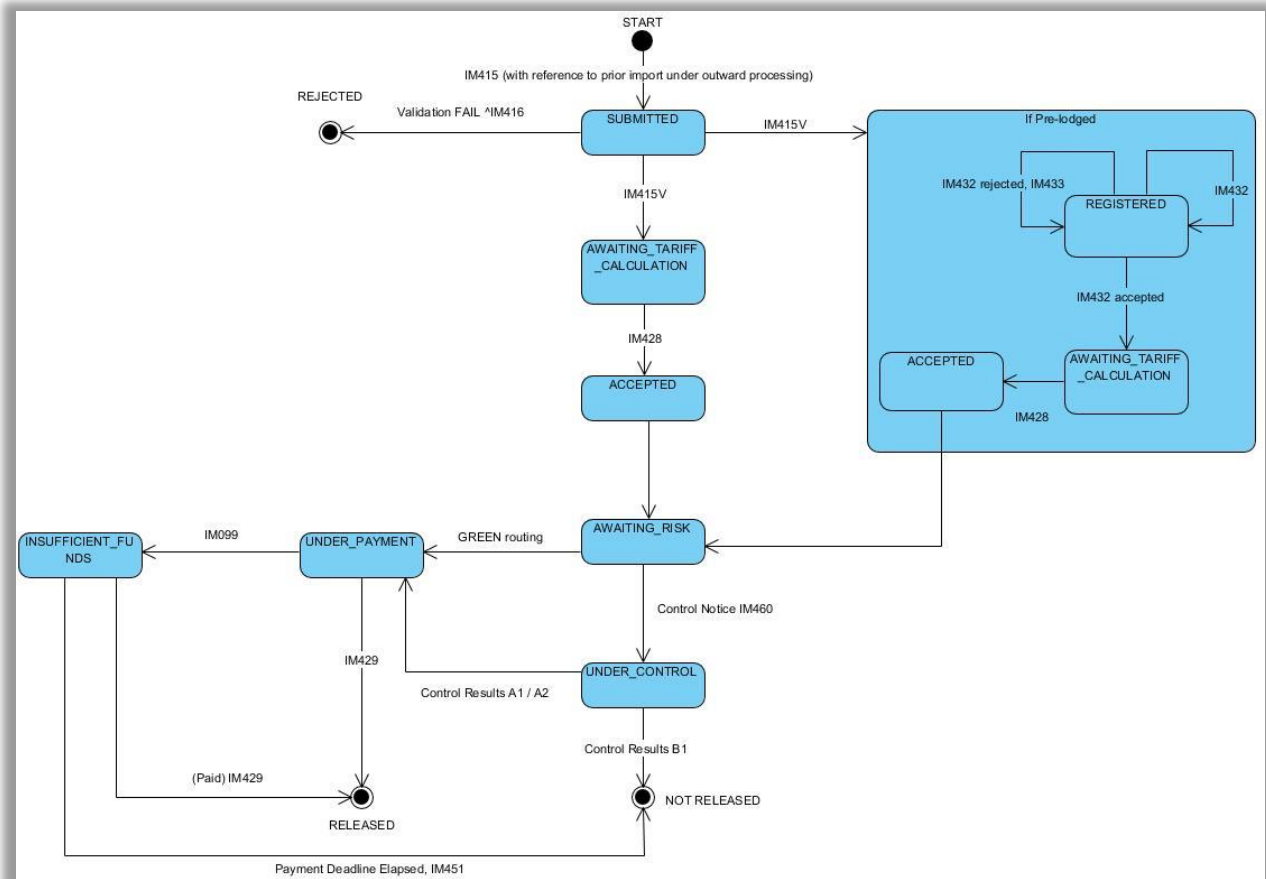

Core Flow (Happy Path) - Placement - Standard Declaration for Special Procedure (H1, H2, H3, H4, I1)

1. AIS receives an IM415 message – Standard Customs Declaration for Special Procedures
2. The message is syntactically valid
3. The message is logically valid (No business rules violation)
4. Declaration is evaluated as “arrived”
5. AIS forwards an IM428 acceptance message to the Trader
6. The declaration is Green routed or positive control results (after Alt 9 step 3)
7. Payment process completed successfully
8. AIS forwards an IM429 Release Notification message to the Trader

Alt 1 - The declaration is syntactically invalid

1. The process follows the core flow up to step 1
2. The IM415 message is syntactically invalid
3. AIS forwards an IM917 Syntax Error Notification message to the Trader

Alt 2 - The declaration is logically invalid

1. The process follows the core flow up to step 2
2. The IM415 message is logically invalid (Business rules violation)
3. AIS forwards an IM416 rejection message to the Trader

Alt 3 - Customs declaration is pre-lodged

1. The process follows the core flow up to step 3
2. AIS forwards an IM415V Customs Declaration Acknowledgment message to the Trader
3. AIS receive IM432 presentation notification
4. IM432 is syntactically valid
5. IM432 is logically valid
6. The IM432 message refers to an “arrived” declaration
7. Process continues from step 5 of the core flow

Alt 4 - Red / orange routing and AEO status

1. The process follows the Alt 3 up to step 2
2. Routing is red / orange and declarant has AEO status
3. IM099 with declaration routing information is sent to the Trader

Alt 5 – Timer for presentation notification is expired

1. The process follows the Alt 3 up to step 2
2. The timer for presentation notification is expired
3. IM451 Release rejection is sent to the Trader

Alt 6 - The presentation notification is syntactically invalid

1. The process follows the Alt 3 up to step 3
2. The IM432 message is syntactically invalid
3. AIS forwards an IM917 Syntax Error Notification message to the Trader

Alt 7 – The presentation notification is logically invalid

1. The process follows the Alt 3 up to step 4
2. The message is logically invalid (Business rules violation)
3. AIS forwards an IM433 rejection message to the Trader

Alt 8 - IM432 refers to a “non-arrived” declaration

1. The process follows the Alt 3 up to step 5
2. IM432 refers to a “non-arrived” declaration
3. AIS forwards an IM433 rejection message to the Trader

Alt 9 – RED/ORANGE Routing

1. The process follows the core flow up to step 5
2. The Declaration is Red/Orange routed
3. AIS forwards an IM460 Control Notice message to the Trader

Alt 10 – CERTEX certificate not finalised or under review

1. The process follows the core flow up to step 6
2. CERTEX certificate is not finalised or under review
3. AIS sends IM099 – “Declaration with DAFM” message to the Trader

Alt 11 - Decision to release the Goods - Entry Refused (Controls)

1. The process follows the Alt 9 to step 3
2. The Goods cannot be released
3. AIS forwards an IM451 release rejection message to the Trader

Alt 12 - Insufficient funds

1. The process follows the core flow up to step 6
2. Customs debt is due, Trader’s Revenue account has insufficient funds
3. AIS sends an IM099 “insufficient funds” information message to the Trader

Alt 13 - Timer for payment expired

1. The process follows the Alt 12 up to step 3
2. Trader has failed to fulfil their financial obligation to Revenue within a specified time-limit
3. AIS sends an IM451 Release Rejection message to the Trader

6.2.3 Simplified and Supplementary Customs Declaration for a Special Procedure

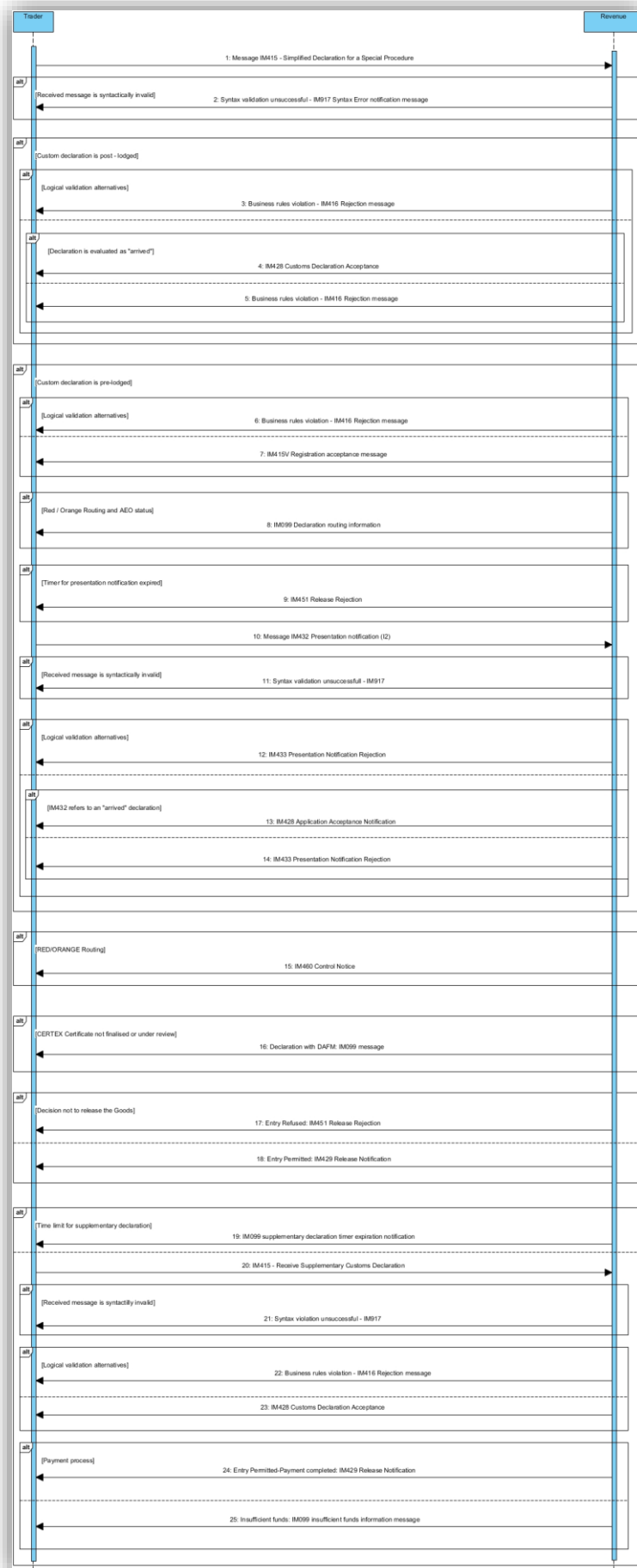

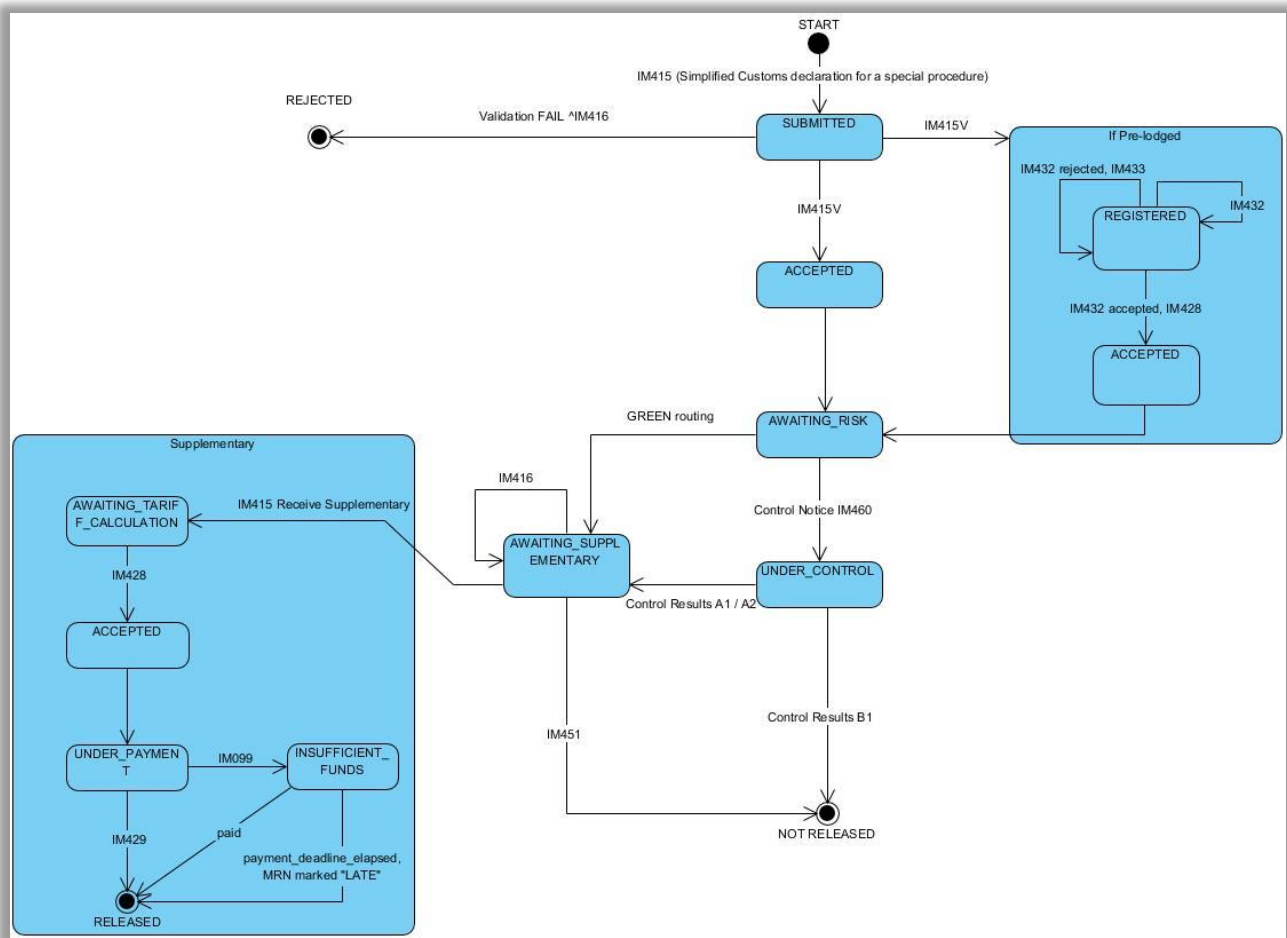

Core Flow (Happy Path) - Placement – Post-logged Simplified and Supplementary Customs Declaration

1. AIS receives an IM415 message - Receive Simplified Customs Declaration for a Special Procedure
2. The declaration is post lodged
3. The message is syntactically valid
4. The message is logically valid (No business rules violation)
5. Declaration is evaluated as “arrived”
6. AIS sends IM428 acceptance message to the Trader
7. The declaration is Green routed or positive control results (after Alt 12 step 3)
8. AIS forwards an IM429 Release Notification message to the Trader
9. AIS receives an IM415 message - Receive Supplementary Customs Declaration
10. The message is syntactically valid
11. The message is logically valid (No business rules violation)
12. AIS forwards an IM428 acceptance message to the Trader
13. Payment process completed successfully
14. AIS forwards an IM429 Release Notification message to the Trader

Alt 1 - Simplified Customs Declaration is syntactically invalid

1. The process follows the core flow up to step 1

2. The IM415 message is syntactically invalid
3. AIS forwards an IM917 Syntax Error Notification message to the Trader

Alt 2 - Simplified Customs Declaration is logically invalid

1. The process follows the core flow up to step 2
2. The IM415 message is logically invalid (Business rules violation)
3. AIS forwards an IM416 rejection message to the Trader

Alt 3 – Simplified Customs Declaration is evaluated as “non-arrived”

1. The process follows the core flow up to step 3
2. Simplified Customs Declaration is evaluated as “non-arrived”
3. AIS forwards IM416 Rejection message

Alt 4 - Simplified Customs Declaration – pre-lodged - Receive Presentation Notification

1. The process follows the core flow up to step 1
2. Declaration is pre-lodged
3. The message is syntactically valid
4. The message is logically valid (No business rules violation)
5. AIS sends IM415V Registration acceptance message to the Trader
6. AIS receives the IM432 message
7. The message is syntactically valid
8. The message is logically valid (No business rules violation)
9. IM432 refers to an “arrived” declaration
10. AIS forwards IM428 Application acceptance notification
11. The process follows the core flow up to step 7

Alt 5 - Simplified Customs Declaration - The presentation notification is syntactically invalid

1. The process follows the Alt 4 up to step 2
2. The IM415 message is syntactically invalid
3. AIS forwards an IM917 Syntax Error Notification message to the Trader

Alt 6 - Simplified Customs Declaration - Invalid presentation notification

1. The process follows the Alt 4 up to step 3
2. The message is logically invalid (Business rules violation)
3. AIS forwards an IM416 rejection message to the Trader

Alt 7 – RED/ORANGE Routing

1. The process follows the Alt 4 up to step 5
2. The Declaration is Orange/Red routed and AEO status
3. AIS forwards an IM099 Declaration routing information to the Trader

Alt 8 – Timer for presentation notification expired

1. The process follows the Alt 4 up to step 5
2. Timer for presentation notification is expired
3. AIS sends IM451 Release rejection

Alt 9 – IM432 is syntactically invalid

1. The process follows the Alt 4 up to step 6
2. IM432 is syntactically invalid
3. AIS sends IM917 Syntax Error Notification message to the Trader

Alt 10 –IM432 is logically invalid

1. The process follows the Alt 4 up to step 7
2. IM432 is logically invalid
3. AIS sends IM433 rejection message to the Trader

Alt 11 – IM432 refers to a “non-arrived” declaration

1. The process follows the Alt 4 up to step 8
2. IM432 refers to an “non-arrived” declaration
3. AIS sends IM433 rejection message to the Trader

Alt 12 – Red / Orange routing

1. The process follows the core flow up to step 6
2. The declaration is red / orange routed
3. AIS sends IM460 control notice message to the Trader

Alt 13 – CERTEX certificate not finalised or under review

1. The process follows the core flow up to step 7
2. CERTEX certificate not finalised or under review
3. AIS sends IM099 – “Declaration with DAFM” to the Trader

Alt 14 - Decision to release the Goods - Entry Refused

1. The process follows the Alt 12 up to step 3
2. The Goods cannot be released
3. AIS forwards an IM451 release rejection message to the Trader

Alt 15 - Time limit for supplementary declaration: Timer for supplementary expired

1. The process follows the core flow up to step 8
2. The timer for Supplementary declaration lodging expired
3. AIS sends IM099 supplementary declaration timer expiration notification

Alt 16 - Supplementary Customs Declaration is syntactically invalid

1. The process follows the core flow up to step 9
2. The IM415 message is syntactically invalid
3. AIS forwards an IM917 Syntax Error Notification message to the Trader

Alt 17 – Supplementary Customs Declaration is logically invalid

1. The process follows the core flow up to step 10
2. The IM415 message is logically invalid (Business rules violation)
3. AIS forwards an IM416 rejection message to the Trader

Alt 18 - Insufficient funds

1. The process follows the core flow up to step 12
2. Customs debt is due, Trader's Revenue account has insufficient funds
3. AIS sends an IM099 "insufficient funds" information message to the Trader

6.2.4 EIDR with Presentation Notification and Supplementary Declaration (Type Z)

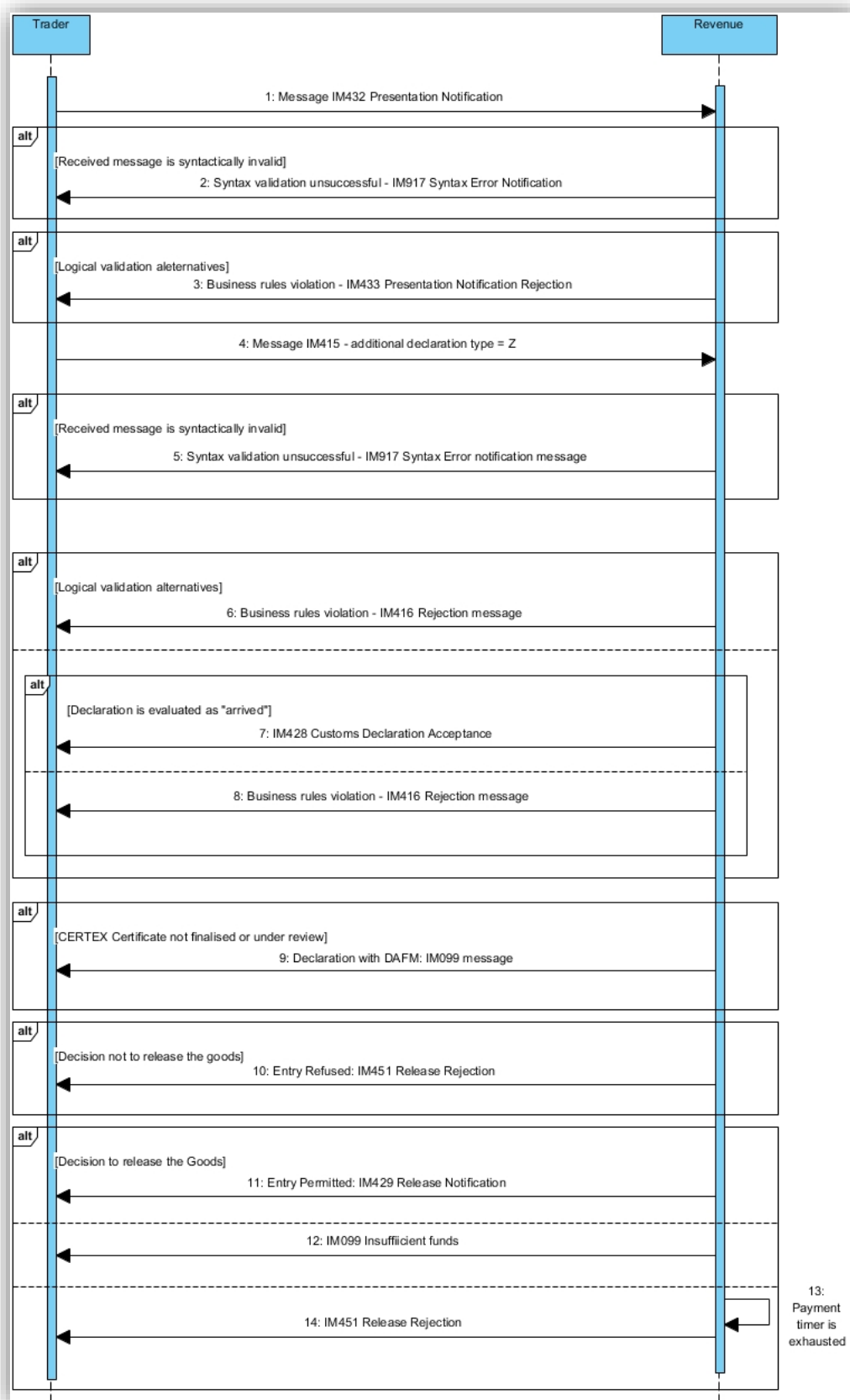

Core Flow (Happy Path) - EIDR with Presentation notification

1. AIS receives IM432 Presentation Notification
2. IM432 is syntactically valid
3. IM432 is logically valid
4. AIS receives an IM415 Supplementary Customs Declaration - Additional declaration type = Z message
5. The message is syntactically valid
6. The message is logically valid (No business rules violation)
7. The declaration is evaluated as “arrived”
8. AIS forwards an IM428 acceptance message to the Trader
9. The payment process is completed successfully
10. AIS sends an IM429 release message to the Trader

Alt 1 - IM432 is syntactically invalid

1. The process follows the core flow up to step 1
2. IM432 is syntactically invalid
3. AIS forwards an IM917 Syntax Error Notification message to the Trader

Alt 2 – IM433 is logically invalid

1. The process follows the core flow up to step 2
2. IM433 is logically invalid (Business rules violation)
3. AIS forwards an IM433 rejection message to the Trader

Alt 3 - The declaration is syntactically invalid

1. The process follows the core flow up to step 4
2. The message is syntactically invalid
3. AIS forwards an IM917 Syntax Error Notification message to the Trader

Alt 4 - The declaration is logically invalid

1. The process follows the core flow up to step 5
2. The message is logically invalid (Business rules violation)
3. AIS forwards an IM416 rejection message to the Trader

Alt 5 – The declaration is evaluated as “non-arrived”

1. The process follows the core flow up to step 6
2. The declaration is evaluated as “non-arrived”
3. AIS sends an IM416 rejection message to the Trader

Alt 6 – CERTEX Certificate not finalised or under review

1. The process follows the core flow up to step 7
2. CERTEX Certificate is not finalised or under review
3. AIS forwards IM099 “Declaration with DAFM” message to the Trader

Alt 7 - The Supplementary declaration is in ‘Insufficient funds’

1. The process follows the core flow up to step 7

2. AIS forwards an IM099 “insufficient funds” information message to the Trader

Alt 8 – Payment timer is exhausted

1. The process follows the Alt 7 up to step 2
2. Payment timer is exhausted
3. AIS forwards IM451 Release rejection message to the Trader

6.2.5 EIDR with Presentation notification waiver and Supplementary Declaration (Type Z)

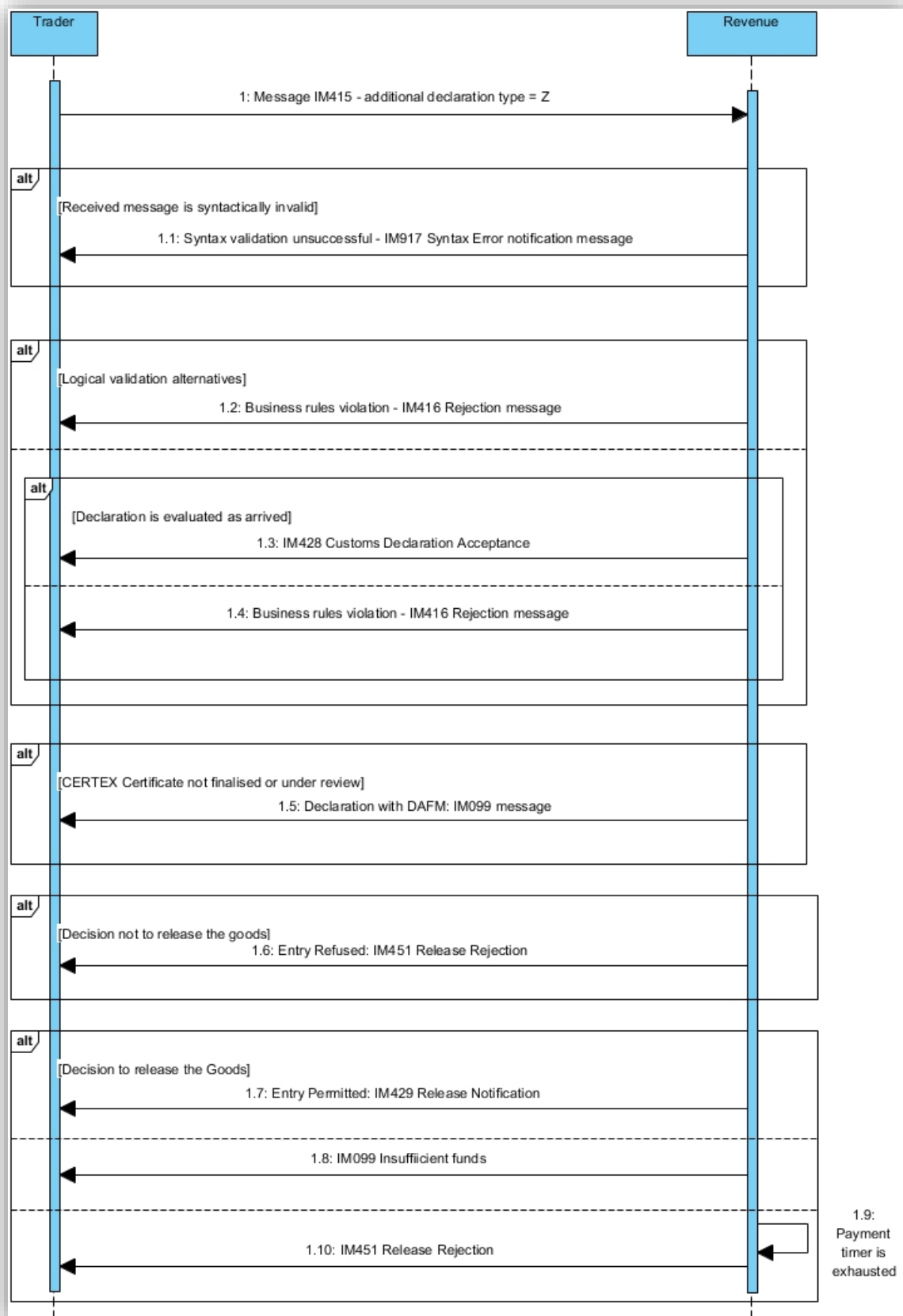

Core Flow (Happy Path) - EIDR - Presentation notification waiver

1. AIS receives an IM415 Supplementary Customs Declaration - Additional declaration type = Z message
2. The message is syntactically valid
3. The message is logically valid (No business rules violation)
4. The declaration is evaluated as “arrived”
5. AIS forwards an IM428 acceptance message to the Trader
6. The payment process is completed successfully
7. AIS sends an IM429 release message to the Trader

Alt 1 - The declaration is syntactically invalid

1. The process follows the core flow up to step 1
2. The message is syntactically invalid
3. AIS forwards an IM917 Syntax Error Notification message to the Trader

Alt 2 - The declaration is logically invalid

1. The process follows the core flow up to step 2
2. The message is logically invalid (Business rules violation)
3. AIS forwards an IM416 rejection message to the Trader

Alt 3 – The declaration is evaluated as “non-arrived”

1. The process follows the core flow up to step 3
2. The declaration is evaluated as “non-arrived”
3. AIS sends an IM416 rejection message to the Trader

Alt 4 – CERTEX Certificate not finalised or under review

1. The process follows the core flow up to step 5
2. CERTEX Certificate is not finalised or under review
3. AIS forwards IM099 “Declaration with DAFM” message to the Trader

Alt 5 - The Supplementary declaration is in ‘Insufficient funds’

1. The process follows the core flow up to step 5
2. AIS forwards an IM099 “insufficient funds” information message to the Trader

Alt 6 – Payment timer is exhausted

1. The process follows the Alt 5 up to step 2
2. Payment timer is exhausted
3. AIS forwards IM451 Release rejection message to the Trader

7 Import - Controls

7.1 Messages

List of messages code and description that may be exchanged

ID	Description	Sent by
IM099	General Notification and Request Information message	AIS
IM917	Syntax Error notification message	AIS
Controls		
IM404	Amendment Request Registration	AIS
IM405	Amendment Request Rejection	AIS
IM409	Invalidation Request Decision	AIS
IM413	Customs Declaration Amendment Request	TRADER
IM414	Invalidation Request	TRADER
IM460	Control Notice	AIS
IM462	Request Declaration Amendment	AIS
IM464	Request Declaration Invalidation	AIS
IM482	Documents Request	AIS
IM483	Documents Received	TRADER
IM484	Request Document Presentation	AIS
IM862	Declaration Amendment Request Cancellation	AIS
IM864	Declaration Invalidation Request Cancellation	AIS
IM882	Documents Upload Request Cancellation	AIS
IM884	Documents Presentation Request Cancellation	AIS

7.2 Use Cases

7.2.1 Declaration Amendment Request

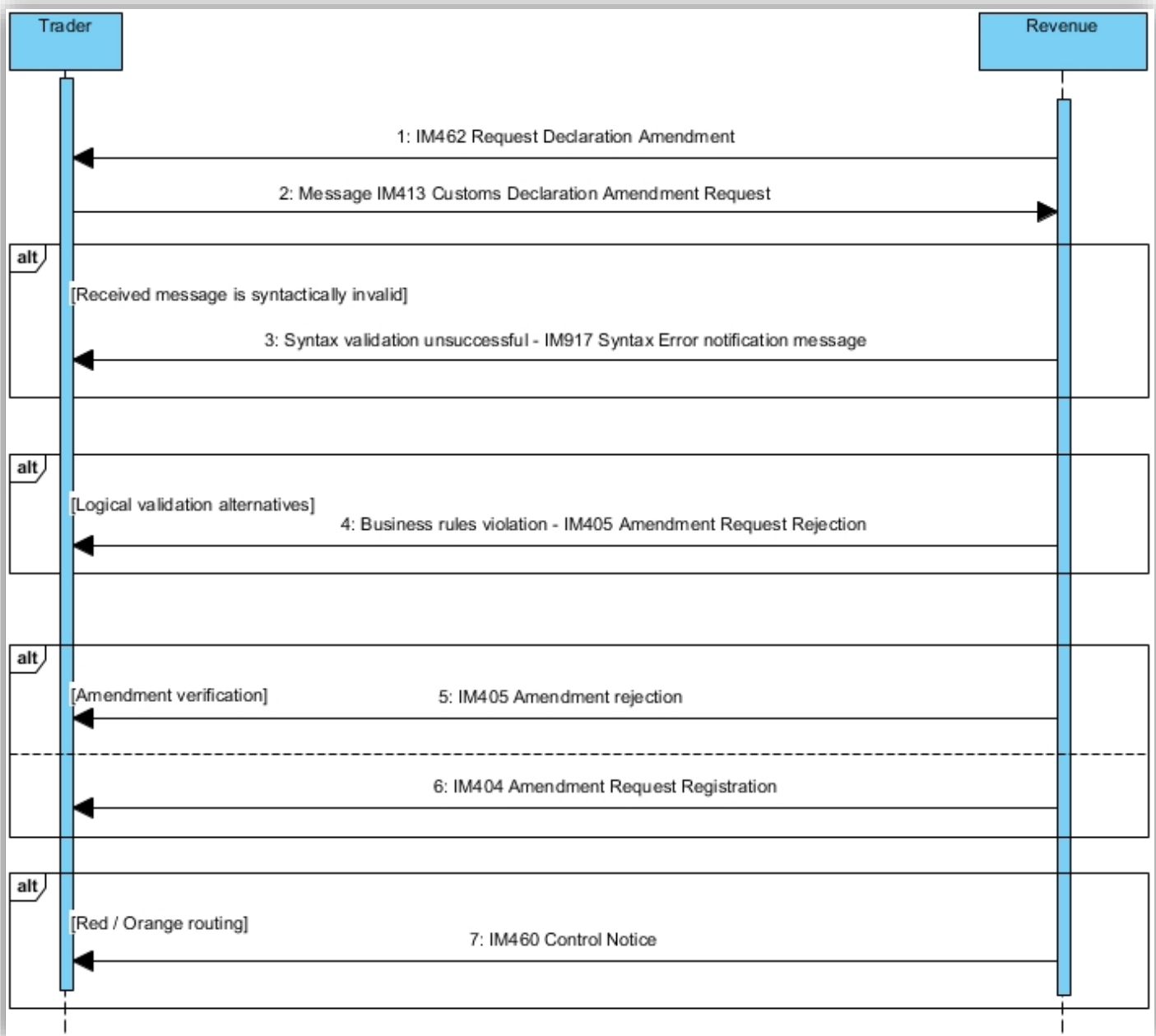

Core Flow (Happy Path) – Customs request for declaration amendment

1. AIS forwards an IM462 Request Declaration Amendment message to the Trader
2. AIS receives an IM413 Customs Declaration Amendment Request message
3. The IM413 message is syntactically valid
4. The IM413 message is logically valid (No business rules violation)
5. Officer verifies and accepts the amendment
6. AIS forwards an IM404 Amendment Request Registration message to the Trader

7. The declaration is Green routed

Alt 1 - The amendment is syntactically invalid

1. The process follows the core flow up to step 2
2. The IM413 message is syntactically invalid
3. AIS forwards an IM917 Syntax Error Notification message to the Trader

Alt 2 - The amendment is logically invalid

1. The process follows the core flow up to step 3
2. The IM413 message is logically invalid (Business rules violation)
3. AIS forwards an IM405 Amendment Request Rejection message to the Trader

Alt 3 – Officer rejects amendment

1. The process follows the core flow up to step 4
2. Officer rejects amendment
3. AIS forwards an IM405 Amendment Request Rejection message to the Trader

Alt 4 – RED/ORANGE Routing

1. The process follows the core flow up to step 6
2. The Declaration is Orange/Red routed
AIS forwards an IM460 Control Notice message to the Trader

7.2.2 Declaration Invalidation Request

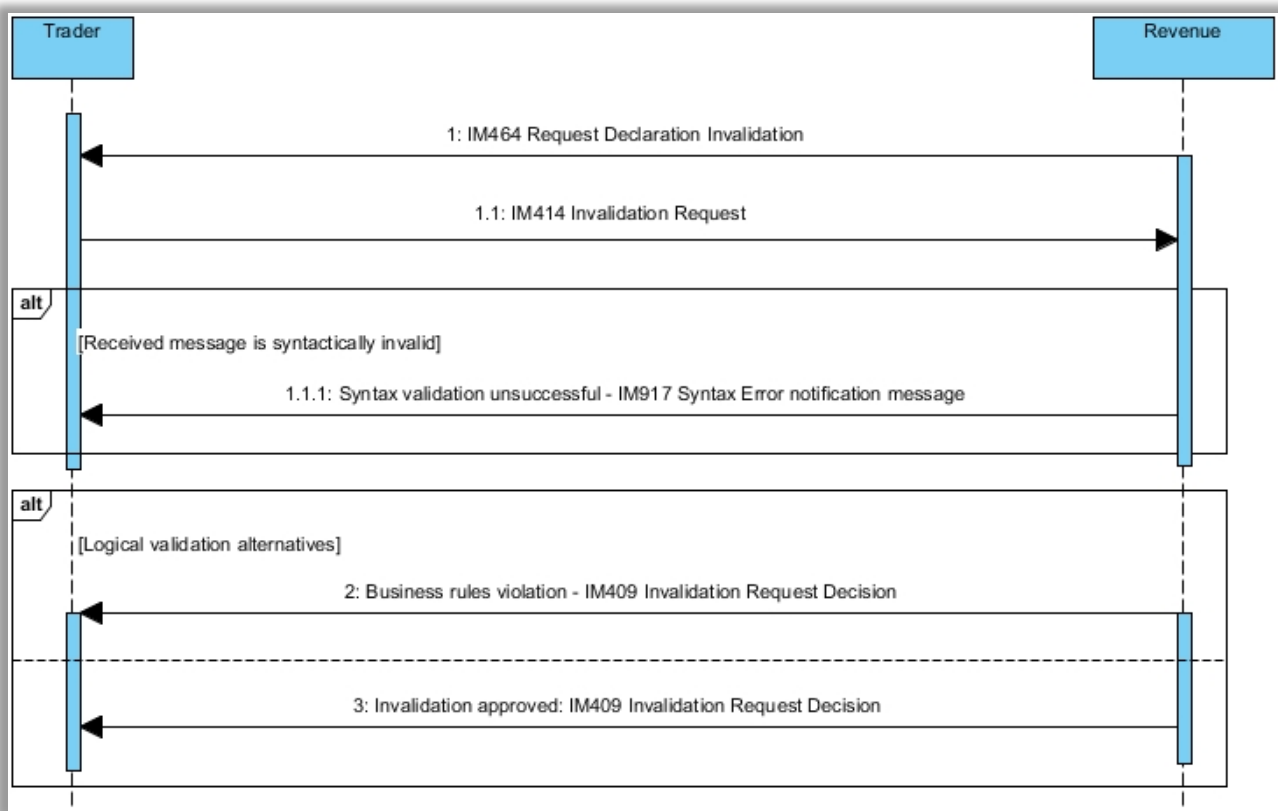

Core Flow (Happy Path) - Request declaration invalidation

1. AIS forwards an IM464 Request Declaration Invalidation message to the Trader
2. AIS receives an IM414 Invalidation Request message
3. The message is syntactically valid
4. The message is logically valid (No business rules violation)
5. AIS forwards an IM409 "Positive" Invalidation Request Decision message to the Trader

Alt 1 - The amendment is syntactically invalid

1. The process follows the core flow up to step 2
2. The IM414 message is syntactically invalid
3. AIS forwards an IM917 Syntax Error Notification message to the Trader

Alt 2 - The amendment is logically invalid

1. The process follows the core flow up to step 3
2. The IM414 message is logically invalid (Business rules violation)
3. AIS forwards an IM409 Invalidation "Negative" Request Decision message to the Trader

7.2.3 Request Document Presentation

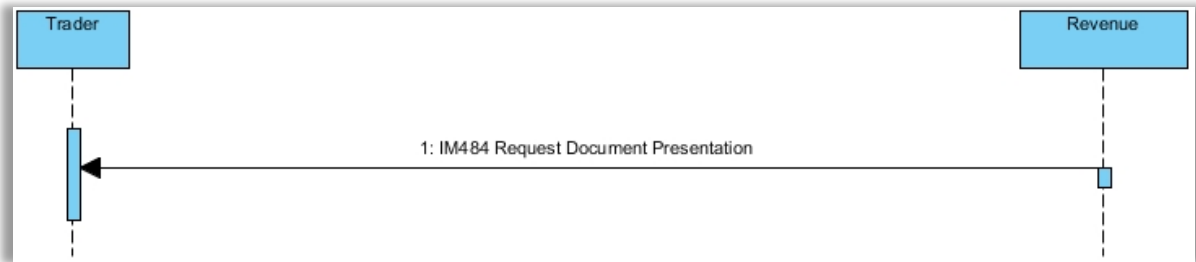

Core Flow (Happy Path) - Request document presentation

1. AIS forwards an IM484 Request Document Presentation message to the Trader
2. The requested documents must be physically presented at any Customs Office

7.2.4 Request Document Upload

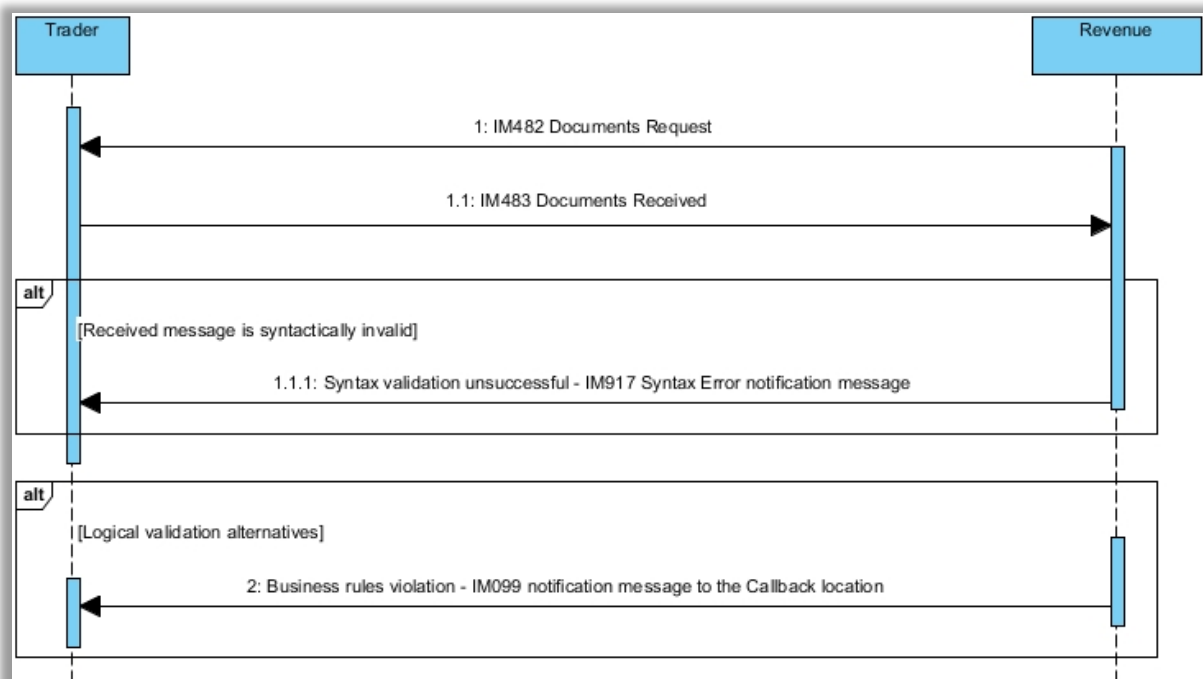

Core Flow (Happy Path) - Request document upload

1. AIS forwards an IM482 Documents Request message to the Trader
2. AIS receives an IM483 Documents Received message
3. The message is syntactically valid
4. The message is logically valid (No business rules violation)

Alt 1 - The upload is syntactically invalid

1. The process follows the core flow up to step 2
2. The IM483 message is syntactically invalid
3. AIS forwards an IM917 Syntax Error Notification message to the Trader

Alt 2 - The upload is logically invalid

1. The process follows the core flow up to step 3
2. The IM483 message is logically invalid (Business rules violation)
3. AIS forwards an IM099 notification message to the Trader with specific logical error(s) description

8 Import - Refunds

8.1 Messages

List of messages code and description that may be exchanged

ID	Description	Sent by
IM917	Syntax Error notification message	AIS
Refunds		
RF415	Refund Application	Trader
RF416	Refund Application message rejection	AIS
RF409	Refund Application Decision	AIS
RD415	Deposit Refund Application	Trader
RD416	Deposit Refund Application message rejection	AIS
RD409	Deposit Refund Application Decision	AIS

8.2 Use Cases

8.2.1 Refund Application

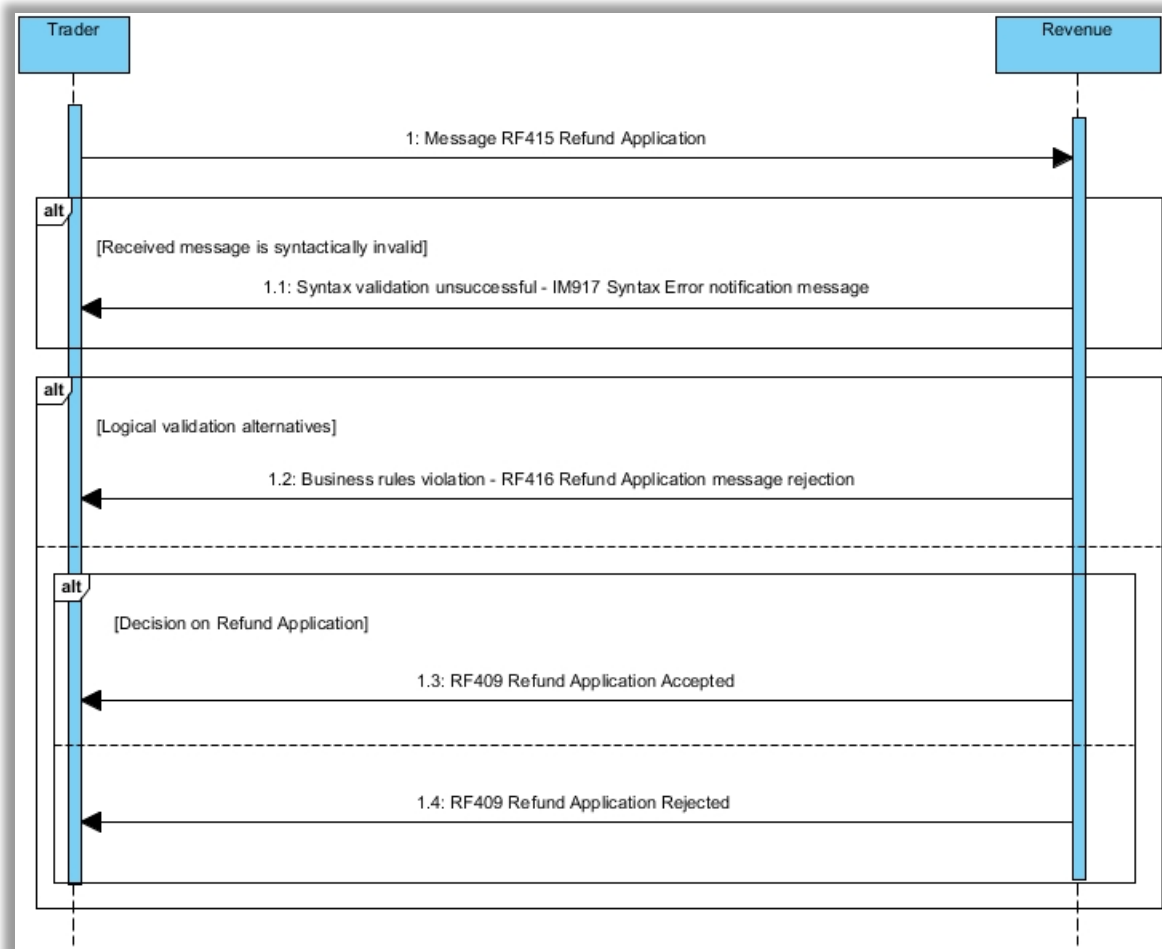

Core Flow – Refund Application

1. AIS receives an RF415 message
2. The message is syntactically valid
3. The message is logically valid (No business rules violation)
4. AIS forwards an RF409 Refund Application approved message to the Trader

Alt 1 - The application is syntactically invalid

1. The process follows the core flow up to step 1
2. The RF416 message is syntactically invalid
3. AIS forwards an IM917 Syntax Error Notification message to the Trader

Alt 2 - The application is logically invalid

1. The process follows the core flow up to step 2
2. The RF415 message is logically invalid (Business rules violation)
3. AIS forwards a RF416 Refund Application message rejection to the Trader

Alt 3 - Decision on Refund Application

1. The process follows the core flow up to step 3
2. AIS forwards a RF409 Refund Application not approved message to the Trader

8.2.2 Deposit Refund Application

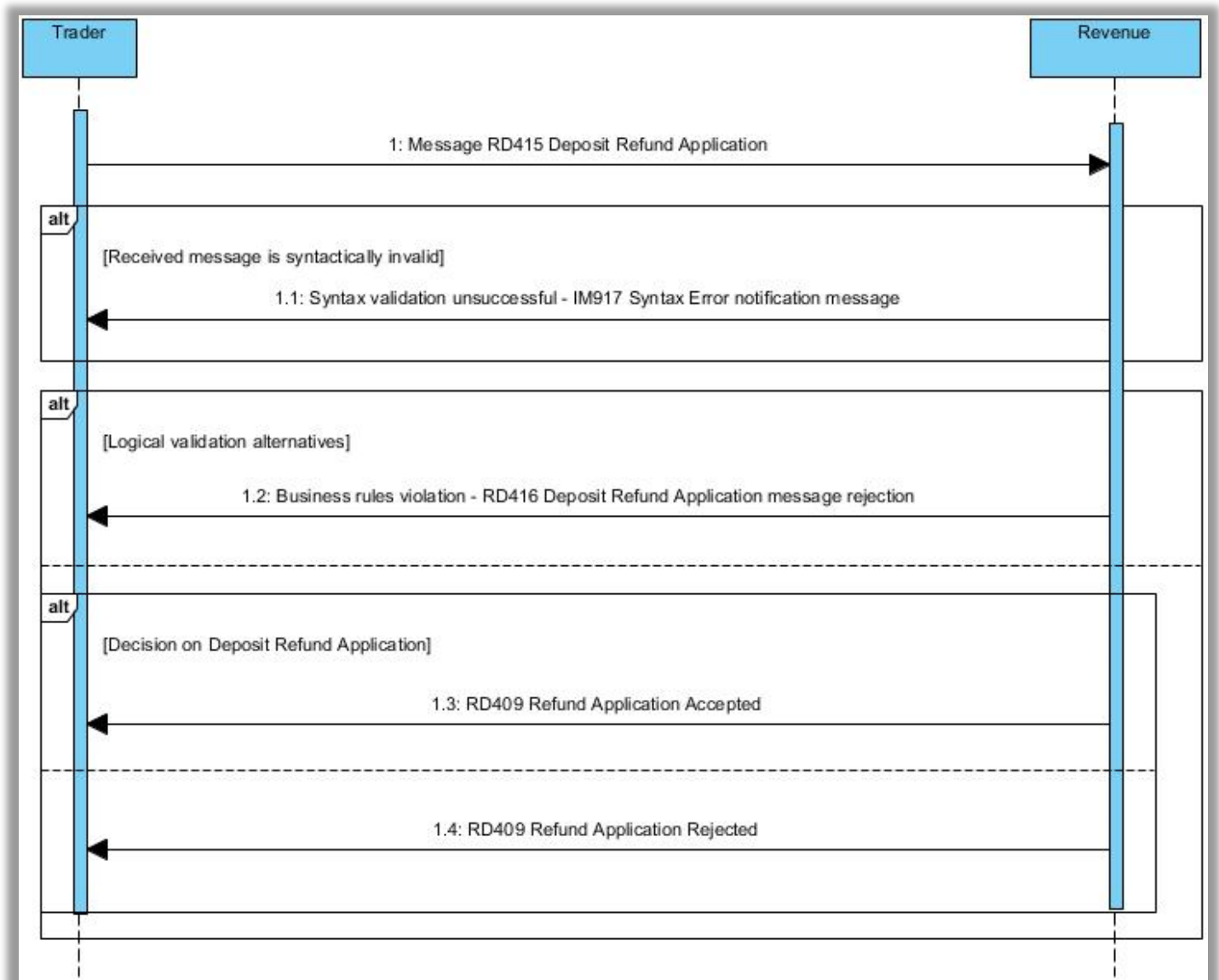

Core Flow – Deposit Refund Application

1. AIS receives an RD415 message
2. The message is syntactically valid
3. The message is logically valid (No business rules violation)
4. AIS forwards an RD409 Deposit Refund Application message with “Positive” result to the Trader

Alt 1 - The application is syntactically invalid

1. The process follows the core flow up to step 1
2. The RD416 message is syntactically invalid
3. AIS forwards an IM917 Syntax Error Notification message to the Trader

Alt 2 - The application is logically invalid

1. The process follows the core flow up to step 2
2. The RD415 message is logically invalid (Business rules violation)
3. AIS forwards a RD416 Refund Application message rejection to the Trader

Alt 3 - Decision on Refund Application

1. The process follows the core flow up to step 3
2. AIS forwards a RD409 Refund Application message with “Negative” result to the Trader

9 Quota Allocation

9.1 Messages

ID	Description	Sent by
Quota		
IM493	Amendment notification for partial or deferred quota allocation	AIS

9.2 Use Cases

9.2.1 Amendment notification for partial or deferred quota allocation

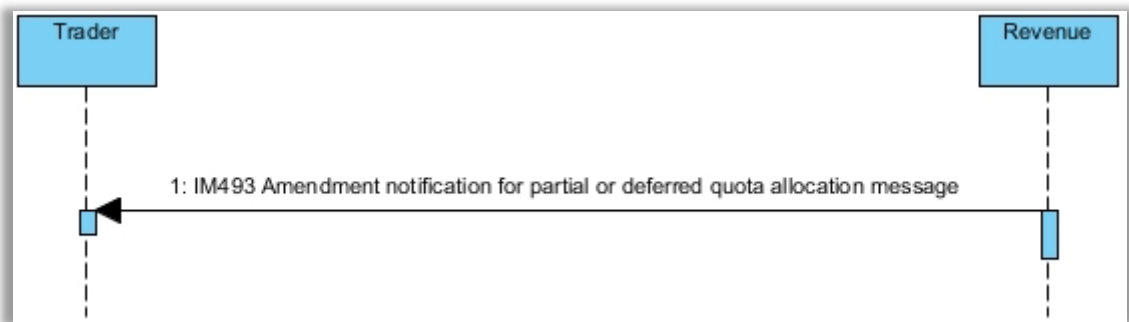

Core Flow (Happy Path) - Amendment notification for partial or deferred quota allocation

1. AIS forwards an IM493 Amendment notification for partial or deferred quota allocation message to the Trader